

QUALITÀ - RAPIDITÀ - CONVENIENZA

QUALITY, SPEED, ECONOMY

CALIDAD, RAPIDEZ, CONVENIENCIA

جودة - سرعة - منفعة

New  
Edition  
2021

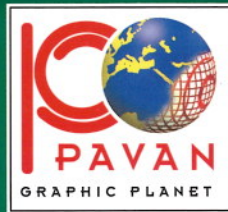

Gli specialisti nella produzione di consumabili per la stampa  
Specialists in the production of consumables for printing  
Los especialistas en la producción de consumibles para la impresión

المختصين في إنتاج المواد المستهلكة للطباعة

PRODUCTS  
COMPATIBLE WITH  
**KOMORI®**  
MACHINES



### ROYAL SUCKERS®

Feeder suckers



P. 9

### RUBBER TEX®

Dual function suckers



P. 11

### LIFTING SUPPORTS FOR SUCKERS



P. 16

### SHEET SEPARATORS

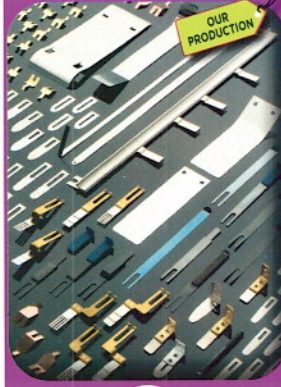

P. 17

### FEEDER BRUSHES



P. 19

### KOMORI GUIDES



P. 20

### ROYAL BELTS®

Feeder belts



P. 24

### FEEDER WHEELS

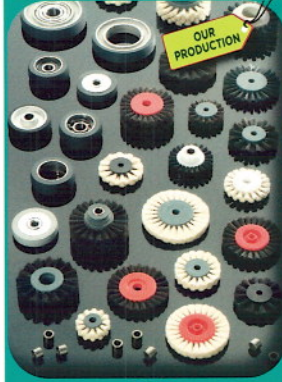

P. 26

Guaranteeing a good recirculation...



P. 28

### MAGIC FILTER PLUS®

Recirculation filters for TECHNTRANS - BALDWIN etc.



P. 29

### FAT VAMPIRE FOUNTAIN®

Recirculating systems fat vampire



P. 31

### MAGIC LIQUID FILTER®



P. 32

### MAGIC AIR FILTER®



P. 33

### CYLINDER JACKET PLANET



P. 34

### ROYAL PRESS®

Cylinder jackets for Die cutting - creasing - punching



P. 35

### IMPRESSION CYLINDER JACKETS CERAMIC TREATED



P. 36

### SPEED FILAY BLUE STANDARD

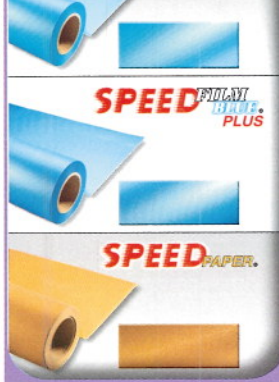

P. 38

### SPECIAL RUBBER WASH

Rubber bladders for blanket and cylinder washing systems BALDWIN - ELETTRA



P. 40

### BLU-TEX®

Blanket washcloth rolls



P. 42

### WHITE-TEX®

Blanket washcloth rolls



P. 42



### BLU-TEX MARINE®

Blanket washcloth rolls



EUROPEAN DISTRIBUTION

CERTIFIED BY fogra

**P. 42**

### SONTARA PRINTMASTER®

Blanket washcloth rolls



ORIGINAL

**P. 42**

### SPIDER TEX

For sheetfed offset and web offset presses



NEW PRODUCT

SPECIAL CLOTH WITH EXCELLENT CLEANING CAPACITY FOR BOTH PRINTING BLANKETS AND PERFECTING CYLINDERS.

- ABRASION RESISTANCE \*\*\*\*\*
- BRAND ADSORPTION \*\*\*\*\*
- INK REMOVAL \*\*\*\*\*
- PAPER DUST REMOVAL \*\*\*\*\*
- LINTING \*\*\*\*\*

LONG ROLL (200 METERS) OR SHORT ROLL AVAILABLE IN ANY WIDTH

**P. 45**

### PERFECTING TEX®

Special washcloth for treated impression cylinder jackets



EUROPEAN DISTRIBUTION

**P. 46**

### PRE-TEX

Mini rotolini pre-impregnati per sistemi di pulizia automatici

Pre-impregnated mini-rolls for automatic washing systems

Mini rotollos pre-impregnati para sistemas automaticos

OUR PRODUCTION

FOR SHEETED OFFSET AND WEB OFFSET PRESSES FOR TRADITIONAL INKS, UV AND H-UV INKS

THE ONLY "CUSTOMIZED" PRE-IMPREGNATED ROLLS IN THE WORLD!

CERTIFIED BY fogra

CMIS technology®

Sistema di Impregnazione Micrometrica Controlata  
Micro-metric Impregnation System  
Controlada Impregnacion Micrometrica Controlada

**P. 47**

### PRE-TEX® FOR WEB-OFFSET



10 Years of PRE-TEX WEB-OFFSET  
10 Years of sales worldwide  
10 Years of technological innovation  
10 Years of QUALITY.

Luca Pavan

Pavan Family Grafiche S.p.A. thanks all their clients who over these 10 years have chosen PRE-TEX WEB for their Goss - Heidelberg - Manroland - Koenig - Komori - Mitsubishi - Timson presses.

**P. 49**

### CONVERSION KIT DRY TO WET



**P. 50**

### SUMITOMO PRINTING BLANKETS®

Top quality for printing blankets



The new generation

EXCLUSIVE PRODUCT

S-PRIA (red)  
S-PRIA BLUE PLUS  
S-PRIA (green)  
SB14

high quality compressible printing blankets for any type of printing

**P. 52**

### ROYAL DOT BLANKETS®

HIGH QUALITY PRINTING BLANKETS



EXCLUSIVE PRODUCT

**P. 53**

### ROYAL DOT BLANKETS®

HIGH QUALITY PRINTING BLANKETS



UNIQUE PRODUCTION TECHNOLOGY

If you mount them correctly ..... you will love them !!!

No thickness loss technology

ROYAL DOT DYNAMIC BLANKETS

THE ONLY PRINTING BLANKETS THAT DO NOT LOSE "THICKNESS" !!!

**P. 53**

### NEW SERVICE P&C

PARKING & CUTTING  
QUALITY, SPEED, ECONOMY



STACKING FOR MORE THAN 350 ROLLS AVAILABLE

NEW PARKING AND CUTTING SERVICE: ALL INCLUDED IN THE PRICE !!!

1) PARKING 2) CUTTING 3) BARRING 4) STAMPING 5) PACKAGING

**P. 56**

### QUICK CUT AND QUICK BAR SERVICE



**P. 58**

### ROYAL DOT ADHESIVE®

PRINTING BLANKETS



@

### ROYAL UNDERBLANKET®

The Only Underblanket With Ground Rubber Surface



EXCLUSIVE PRODUCT

**P. 59**

### SUPER-PACK®

Calibrated underpacking paper  
The only certified ones in the world



EUROPEAN EXCLUSIVE

CERTIFIED BY fogra

**P. 60**

### HIGHLANDER PACK INFINITY®

Structural Underpacking  
PATENTED



PATENTED HIGHLANDER PACK INFINITY STRUCTURAL UNDERPACKING

EXCLUSIVE PRODUCT

ADHESIVE VERSION NOW AVAILABLE

**P. 62**

### HICKEY REMOVERS



OUR PRODUCTION

**P. 64**

### SUNDRIES



OUR PRODUCTION

**P. 64**

### PERFECTO®

Ink Duct foils for KBA - KOMORI - MANROLAND



**P. 68**

### CLEANING PRODUCTS

Cleaning accessories



EXCLUSIVE PRODUCT

**P. 69**



### FOILTIX® FOILTIX® PERFECTING

Woven non-woven in cut pieces for manual cleaning

OUR PRODUCTION

P. 72

### ALL-TEX UNIVERSAL

THE NEW MICRO-PERFORATED CLOTH FOR MANUAL CLEANING

P. 73

### FOLEX PACK FOIL®

Underpacking polyester Adhesive and Non-adhesive

P. 74

### INK BIN® UNIVERSAL INK WASTE TRAY

P. 75

### PERFECT BLADES®

Wash-up blades for ink rollers 2000 DIFFERENT BLADES

OUR PRODUCTION

P. 76

### SUPER COAT SEALS®

Lateral Coat Seals for coating units

OUR PRODUCTION

P. 82

### ROYAL CUTTER FOR DOCTOR BLADES

The new Royal Cutter for Doctor Blades allows you to cut to the size you need. The product can be regulated to make a cutter for you, or have custom size versions with variable maximum adjustment.

NEW

THE WIDTH AND THE HEIGHT CAN BE REGULATED

SIZE	DESCRIPTION	SIZE
1874H	ROYAL CUTTER SIZE 180mm	
1874L	ROYAL CUTTER SIZE 180mm	
1874E	ROYAL CUTTER SIZE 170mm	

P. 86

### SUPER DOCTOR BLADES

Blades for coating units in STEEL and PLASTIC

EXCLUSIVE PRODUCT

P. 87

### SPECIAL ANILOX SPONGE®

SPECIAL SPONGE FOR OPTIMAL CLEANING OF THE ANILOX CYLINDER.

ESPECIAL SPECIALE PER UNA PULIZIA OTTIMALE DEL CILINDRO ANILOX. ESPECIAL ESPECIAL PARA UNA LIMPIEZA OPTIMA DEL CILINDRO ANILOX.

MINIMUM ORDER 50 PCS

Special top quality material. Maximum efficiency of cleaning. Quality material special de primera calidad.

PERFECT FOR EVERY ANILOX OCCASION. PERFETTO PER OGNI TIPO DI ANILOX. PERFECTO PARA CUALQUIER CASO DEL CILINDRO ANILOX.

REQUEST BY E-MAIL THE PRICE LIST REFERRED FOR YOU. RICHIEDETE PER E-MAIL LA LISTA DEI PREZZI. SOLICITE POR CORREO ELECTRONICO LA LISTA DE PRECIOS.

P. 88

### ROYAL TOP PLATES®

Coating Plates for Water-Based and UV Coatings mm. 1,15 - 1,35 - 1,95

EXCLUSIVE PRODUCT

P. 89

### ROYAL COAT

Coating Plates in Rubber mm. 1,15 - 1,35 - 1,95

EXCLUSIVE PRODUCT

P. 90

### ROYAL UNDER COAT®

Underpacking specific for coating plates

ROYAL UNDER COAT® UNDERPACKING SPECIFIC FOR COATING PLATES

THICKNESS (mm)
0,65
0,75
0,85
0,90
0,95
1,00
1,05
1,10
1,20
1,30
1,40
1,45
1,50
1,55
1,65
1,70
1,75
1,85
1,95
2,00
2,05
2,10
2,15
2,20
2,30

Surface: Fabric Tolerance +/- 0,01

FOGRA CERTIFICATION IN PREPARATION

P. 91

### SUPER COAT®

Coating Plates for off-line varnishing mm. 0,53 - 0,70

EXCLUSIVE PRODUCT

P. 92

### SHEET SLOWDOWN BELTS

P. 93

### MAGNIFYING GLASSES

Magnifiers and microscopes

EXCLUSIVE PRODUCT

P. 95

### ROYAL INSTRUMENTS

Measuring and controlling instruments

EXCLUSIVE PRODUCT

P. 97

### ROYAL PERF®

Rules for perforating, creasing and punching in offset

EUROPEAN EXCLUSIVE

@

### ROYAL ANTISTATIC®

Economical antistatic devices

EUROPEAN EXCLUSIVE

@

### SUPER DAMP®

Damper covers in vegetable fibre for developers, plate-washers and dampening rollers

EUROPEAN DISTRIBUTION

@

### NEW MOL®

Damper covers in vegetable fibre for developers, plate-washers and dampening rollers

ALWAYS THE BEST!

SEI VALUTO MOLTA CHE SCONTO "NEW MOL" SULLA LISTA PREZZI.

Esistono alternative di qualità e di assistenza. Molta attenzione, sempre pratica ed efficace. Saper risolvere i problemi. Saper rispondere ai clienti. Saper ascoltare e capire. Saper consigliare e suggerire. Saper lavorare in gruppo. Saper lavorare con stile. Saper lavorare con passione.

LA STRADA DI CHIAMA DI "NEW MOL" E' UNO DEI PIU' SEMPLICI E' UNO DEI PIU' EFFICACI. SPECIAMENTE PER CHI HA A CHE FARE CON I CLIENTI.

ORIGINAL

@



# LEGENDA COLORI E SPESSORI . COLOUR AND THICKNESS KEY . LEYENDA DE COLOR Y DE ESPESOR

NOME - NAME - NOMBRE	SPESSORE THICKNESS - ESPESOR
NORMAL	0,5 mm
STANDARD	0,8 mm
STANDARD SUPER RELEASE	0,8 mm
BIS	1,0 mm
BIS SUPER RELEASE	1,0 mm

NOME - NAME - NOMBRE	SPESSORE THICKNESS - ESPESOR
ULTRA	1,5 mm
SUPER	2,0 mm
SILICONE	1,0 mm
SILICONE	1,5 mm
RUBBERTEX	

GOMMA NATURALE  
NATURAL RUBBER  
CAUCHO NATURAL

**NORMAL**



SPESSORE/THICKNESS/ESPESOR  
**0,5 mm - 0,20"**

GOMMA NATURALE COLORATA  
COLOURED NATURAL RUBBER  
CAUCHO NATURAL COLOREADO

**STANDARD**



SPESSORE/THICKNESS/ESPESOR  
**0,8 mm - 0,31"**

GOMMA NATURALE COLORATA  
COLOURED NATURAL RUBBER  
CAUCHO NATURAL COLOREADO

**STANDARD  
SUPER RELEASE**



SPESSORE/THICKNESS/ESPESOR  
**0,8 mm - 0,31"**

GOMMA NATURALE COLORATA  
COLOURED NATURAL RUBBER  
CAUCHO NATURAL COLOREADO

**BIS**



SPESSORE/THICKNESS/ESPESOR  
**1,0 mm - 0,40"**

GOMMA NATURALE COLORATA  
COLOURED NATURAL RUBBER  
CAUCHO NATURAL COLOREADO

**BIS  
SUPER RELEASE**



SPESSORE/THICKNESS/ESPESOR  
**1,0 mm - 0,40"**

GOMMA NATURALE  
NATURAL RUBBER  
CAUCHO NATURAL

**ULTRA**



SPESSORE/THICKNESS/ESPESOR  
**1,5 mm - 0,60"**

GOMMA NATURALE  
NATURAL RUBBER  
CAUCHO NATURAL

**SUPER**



SPESSORE/THICKNESS/ESPESOR  
**2,0 mm - 0,80"**

SILICONE  
SILICONE  
SILICONA

**SILICONE**



SPESSORE/THICKNESS/ESPESOR  
**1,0 mm - 0,40"**

SILICONE  
SILICONE  
SILICONA

**SILICONE**



SPESSORE/THICKNESS/ESPESOR  
**1,5 mm - 0,60"**

**RubberTex®**  
dual function suckers

**SPECIAL**



Side for  
Cardboard

Side for  
Paper

**RubberTex Thickness**



# RubberTex®

## dual function suckers



HIGH PERFORMANCE, DUAL FUNCTION FLAT SUCKERS  
 PRODUCED WITH CLOTH ON ONE SIDE (FOR PAPER)  
 AND WITH SPECIAL RUBBER ON THE OTHER SIDE (FOR CARDBOARD)

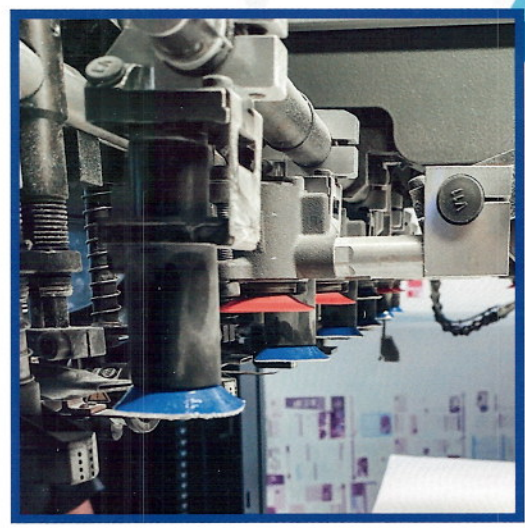
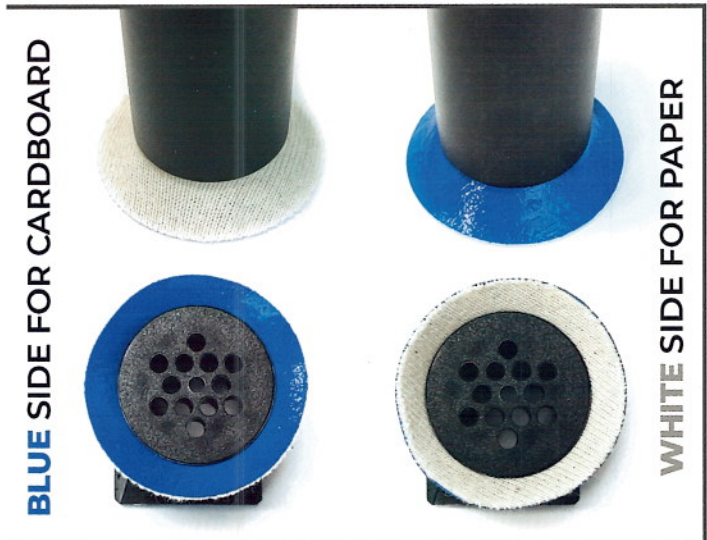

CODICE - CODE - CÓDIGO	SPESSORE THICKNESS - ESPESOR	Ø ESTERNO - Ø OUTSIDE	Ø INTERNO - Ø INSIDE
7772	RubberTex	30 mm	13 mm

CODICE - CODE - CÓDIGO	SPESSORE THICKNESS - ESPESOR	Ø ESTERNO - Ø OUTSIDE	Ø INTERNO - Ø INSIDE
8012	RubberTex	33 mm	15 mm

CODICE - CODE - CÓDIGO	SPESSORE THICKNESS - ESPESOR	Ø ESTERNO - Ø OUTSIDE	Ø INTERNO - Ø INSIDE
7932	RubberTex	32 mm	13 mm

CODICE - CODE - CÓDIGO	SPESSORE THICKNESS - ESPESOR	Ø ESTERNO - Ø OUTSIDE	Ø INTERNO - Ø INSIDE
8332	RubberTex	38 mm	14 mm

CODICE - CODE - CÓDIGO	SPESSORE THICKNESS - ESPESOR	Ø ESTERNO - Ø OUTSIDE	Ø INTERNO - Ø INSIDE
7972	RubberTex	32 mm	15 mm

CODICE - CODE - CÓDIGO	SPESSORE THICKNESS - ESPESOR	Ø ESTERNO - Ø OUTSIDE	Ø INTERNO - Ø INSIDE
8372	RubberTex	39 mm	15 mm

MISURE REALI - REAL SIZES - MEDIDAS REALES - MISURE REALI - REAL SIZES - MEDIDAS REALES





NOME - NAME - NOMBRE	SPESSORE THICKNESS - ESPESOR
NORMAL	0,5 mm
STANDARD	0,8 mm
STANDARD SUPER RELEASE	0,8 mm
BIS	1,0 mm
BIS SUPER RELEASE	1,0 mm
ULTRA	1,5 mm
SUPER	2,0 mm
SILICONE	1,0 mm
SILICONE	1,5 mm
RUBBERTEX	

MISURE REALI - REAL SIZES - MEDIDAS REALES - MISURE REALI - REAL SIZES - MEDIDAS REALES - MISURE REALI - REAL SIZES - MEDIDAS REALES

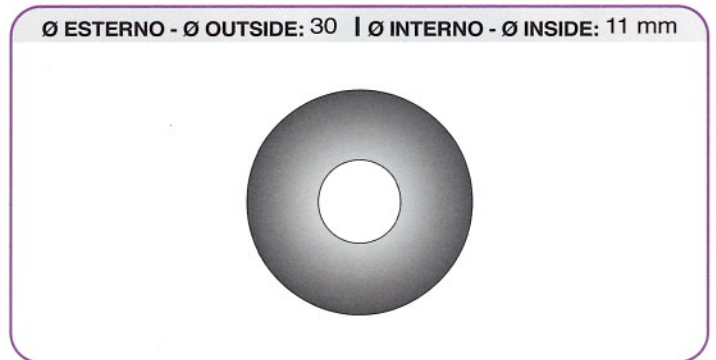
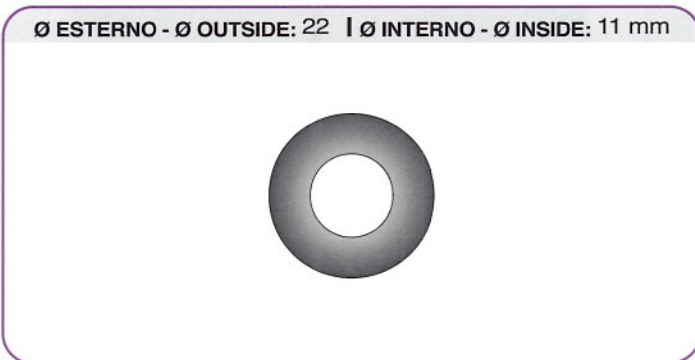

CODICE - CODE - CÓDIGO	SPESSORE THICKNESS - ESPESOR
7290-A	0,5 mm
7292	0,8 mm
7297	0,8 mm
7293	1,0 mm
7298	1,0 mm

CODICE - CODE - CÓDIGO	SPESSORE THICKNESS - ESPESOR
7294	1,5 mm
7295	2,0 mm
7296	1,0 mm
7299	1,5 mm
	RubberTex

CODICE - CODE - CÓDIGO	SPESSORE THICKNESS - ESPESOR
7720	0,5 mm
7722	0,8 mm
7723	0,8 mm
7724	1,0 mm
7725	1,0 mm

CODICE - CODE - CÓDIGO	SPESSORE THICKNESS - ESPESOR
7726	1,5 mm
7728	2,0 mm
7729	1,0 mm
7730	1,5 mm
	RubberTex

MISURE REALI - REAL SIZES - MEDIDAS REALES - MISURE REALI - REAL SIZES - MEDIDAS REALES - MISURE REALI - REAL SIZES - MEDIDAS REALES

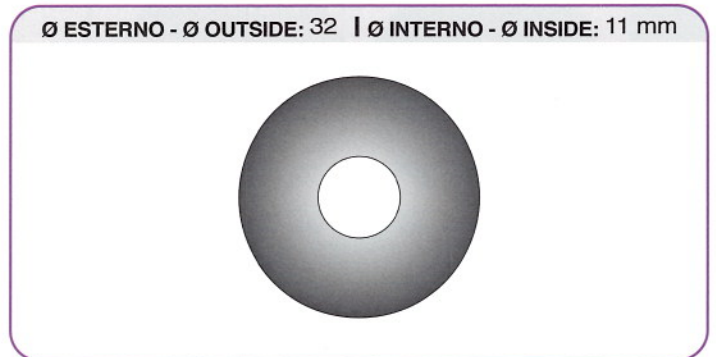
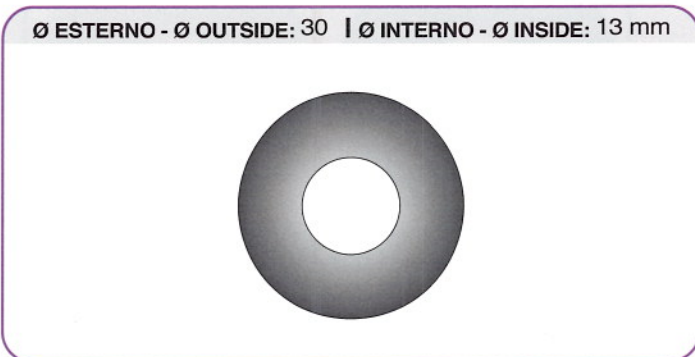

CODICE - CODE - CÓDIGO	SPESSORE THICKNESS - ESPESOR
7760	0,5 mm
7762	0,8 mm
7763	0,8 mm
7764	1,0 mm
7765	1,0 mm

CODICE - CODE - CÓDIGO	SPESSORE THICKNESS - ESPESOR
7766	1,5 mm
7768	2,0 mm
7770	1,0 mm
7771	1,5 mm
7772	RubberTex

CODICE - CODE - CÓDIGO	SPESSORE THICKNESS - ESPESOR
7880	0,5 mm
7882	0,8 mm
7883	0,8 mm
7884	1,0 mm
7885	1,0 mm

CODICE - CODE - CÓDIGO	SPESSORE THICKNESS - ESPESOR
7886	1,5 mm
7888	2,0 mm
7889	1,0 mm
7890	1,5 mm
	RubberTex



Ø ESTERNO - Ø OUTSIDE: 32 | Ø INTERNO - Ø INSIDE: 13 mm



CODICE - CODE - CÓDIGO	SPESSORE THICKNESS - ESPESOR
7920	0,5 mm
7922	0,8 mm
7923	0,8 mm
7924	1,0 mm
7925	1,0 mm

CODICE - CODE - CÓDIGO	SPESSORE THICKNESS - ESPESOR
7926	1,5 mm
7928	2,0 mm
7930	1,0 mm
7931	1,5 mm
7932	RubberTex

Ø ESTERNO - Ø OUTSIDE: 32 | Ø INTERNO - Ø INSIDE: 14 mm

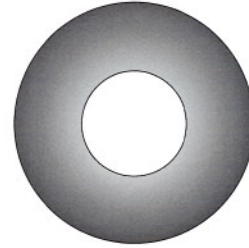

CODICE - CODE - CÓDIGO	SPESSORE THICKNESS - ESPESOR
7940	0,5 mm
7942	0,8 mm
7943	0,8 mm
7944	1,0 mm
7945	1,0 mm

CODICE - CODE - CÓDIGO	SPESSORE THICKNESS - ESPESOR
7946	1,5 mm
7948	2,0 mm
7949	1,0 mm
7950	1,5 mm
	RubberTex

MISURE REALI - REAL SIZES - MEDIDAS REALES - MISURE REALI - REAL SIZES - MEDIDAS REALES - MISURE REALI - REAL SIZES - MEDIDAS REALES

Ø ESTERNO - Ø OUTSIDE: 32 | Ø INTERNO - Ø INSIDE: 15 mm



CODICE - CODE - CÓDIGO	SPESSORE THICKNESS - ESPESOR
7960	0,5 mm
7962	0,8 mm
7963	0,8 mm
7964	1,0 mm
7965	1,0 mm

CODICE - CODE - CÓDIGO	SPESSORE THICKNESS - ESPESOR
7966	1,5 mm
7968	2,0 mm
7969	1,0 mm
7970	1,5 mm
7972	RubberTex

Ø ESTERNO - Ø OUTSIDE: 33 | Ø INTERNO - Ø INSIDE: 15 mm

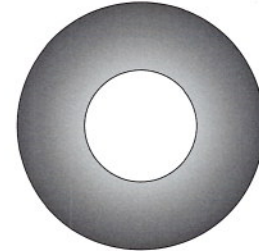

CODICE - CODE - CÓDIGO	SPESSORE THICKNESS - ESPESOR
8000	0,5 mm
8002	0,8 mm
8003	0,8 mm
8004	1,0 mm
8005	1,0 mm

CODICE - CODE - CÓDIGO	SPESSORE THICKNESS - ESPESOR
8006	1,5 mm
8008	2,0 mm
8009	1,0 mm
8010	1,5 mm
8012	RubberTex

MISURE REALI - REAL SIZES - MEDIDAS REALES - MISURE REALI - REAL SIZES - MEDIDAS REALES - MISURE REALI - REAL SIZES - MEDIDAS REALES

Ø ESTERNO - Ø OUTSIDE: 35 | Ø INTERNO - Ø INSIDE: 14 mm

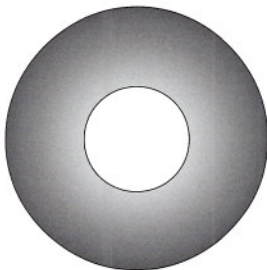

CODICE - CODE - CÓDIGO	SPESSORE THICKNESS - ESPESOR
8140	0,5 mm
8142	0,8 mm
8143	0,8 mm
8144	1,0 mm
8145	1,0 mm

CODICE - CODE - CÓDIGO	SPESSORE THICKNESS - ESPESOR
8146	1,5 mm
8148	2,0 mm
8149	1,0 mm
8150	1,5 mm
	RubberTex

Ø ESTERNO - Ø OUTSIDE: 38 | Ø INTERNO - Ø INSIDE: 11 mm



CODICE - CODE - CÓDIGO	SPESSORE THICKNESS - ESPESOR
8260	0,5 mm
8262	0,8 mm
8263	0,8 mm
8264	1,0 mm
8265	1,0 mm

CODICE - CODE - CÓDIGO	SPESSORE THICKNESS - ESPESOR
8266	1,5 mm
8268	2,0 mm
8269	1,0 mm
8270	1,5 mm
	RubberTex



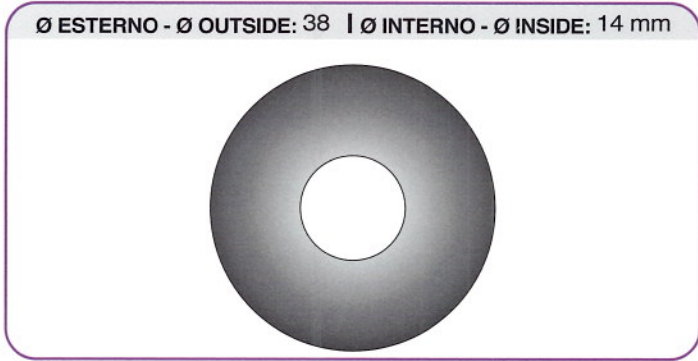

CODICE - CODE - CÓDIGO	SPESSORE THICKNESS - ESPESOR
8320	0,5 mm
8322	0,8 mm
8323	0,8 mm
8324	1,0 mm
8325	1,0 mm

CODICE - CODE - CÓDIGO	SPESSORE THICKNESS - ESPESOR
8326	1,5 mm
8328	2,0 mm
8330	1,0 mm
8329	1,5 mm
8332	RubberTex

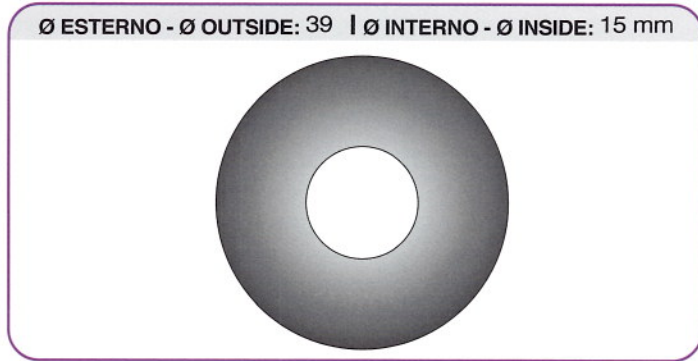

CODICE - CODE - CÓDIGO	SPESSORE THICKNESS - ESPESOR
8360	0,5 mm
8362	0,8 mm
8363	0,8 mm
8364	1,0 mm
8365	1,0 mm

CODICE - CODE - CÓDIGO	SPESSORE THICKNESS - ESPESOR
8366	1,5 mm
8368	2,0 mm
8369	1,0 mm
8370	1,5 mm
8372	RubberTex

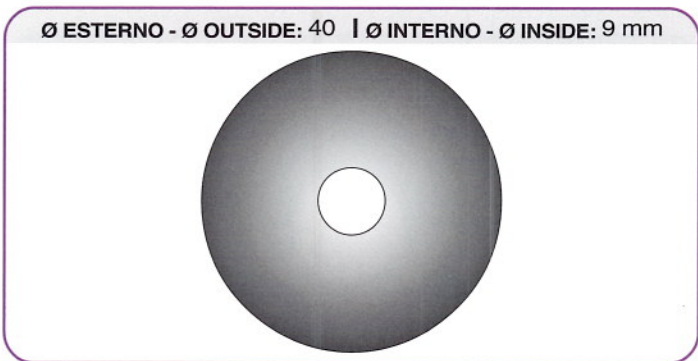

CODICE - CODE - CÓDIGO	SPESSORE THICKNESS - ESPESOR
8380	0,5 mm
8382	0,8 mm
8383	0,8 mm
8384	1,0 mm
8385	1,0 mm

CODICE - CODE - CÓDIGO	SPESSORE THICKNESS - ESPESOR
8386	1,5 mm
8388	2,0 mm
8389	1,0 mm
8390	1,5 mm
	RubberTex

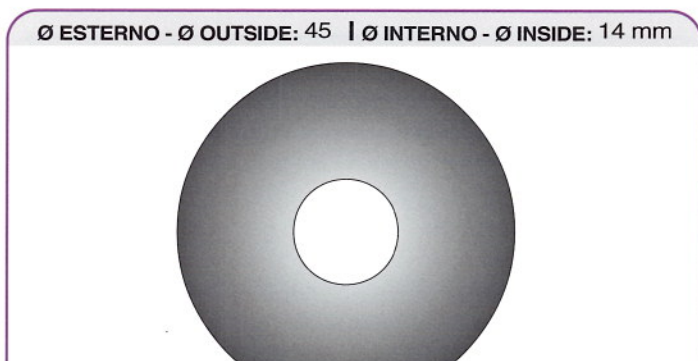

CODICE - CODE - CÓDIGO	SPESSORE THICKNESS - ESPESOR
8520	0,5 mm
8522	0,8 mm
8523	0,8 mm
8524	1,0 mm
8525	1,0 mm

CODICE - CODE - CÓDIGO	SPESSORE THICKNESS - ESPESOR
8526	1,5 mm
8528	2,0 mm
8529	1,0 mm
8530	1,5 mm
	RubberTex

MISURE REALI - REAL SIZES - MEDIDAS REALES - MISURE REALI - REAL SIZES - MEDIDAS REALES - MISURE REALI - REAL SIZES - MEDIDAS REALES

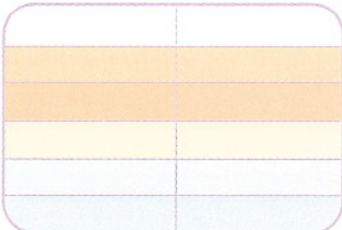
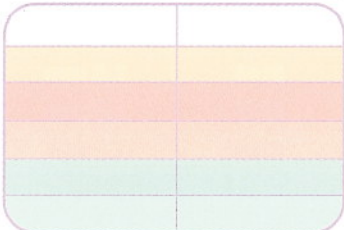
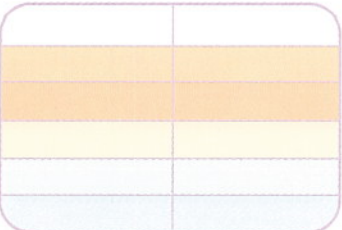
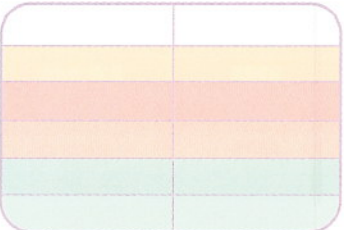
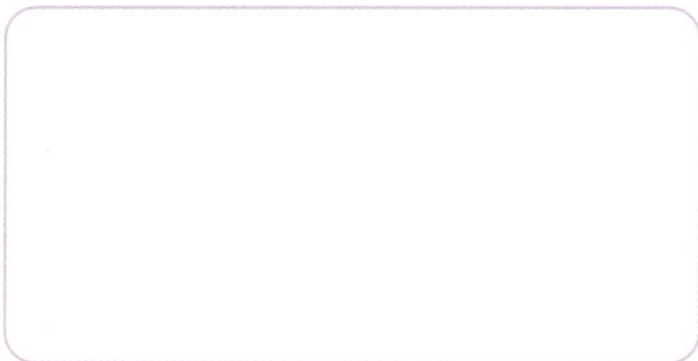
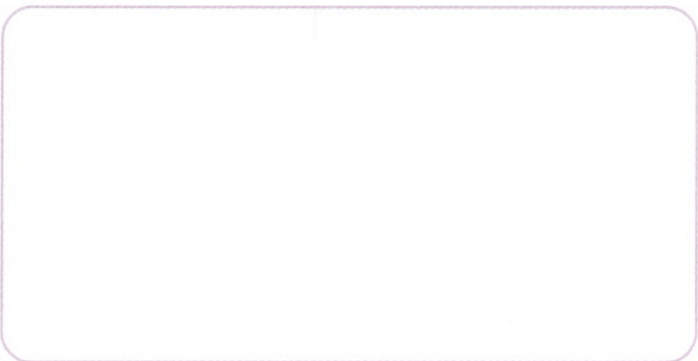



# VENTOSE SAGOMATE - SHAPED SUCKERS - VENTOSAS MOLDEADAS

MISURE REALI - REAL SIZE - MEDIDAS REALES - MISURE REALI - REAL SIZE - MEDIDAS REALES - MISURE REALI - REAL SIZE - MEDIDAS REALES

**9012 BLACK**

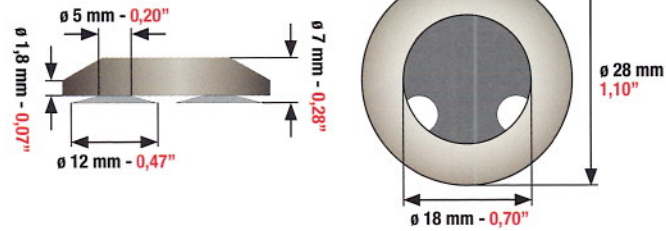

**KOMORI**



MISURE REALI - REAL SIZE - MEDIDAS REALES - MISURE REALI - REAL SIZE - MEDIDAS REALES - MISURE REALI - REAL SIZE - MEDIDAS REALES

**9134**

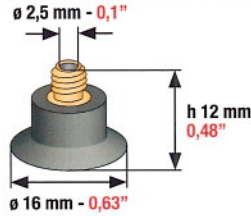

VENTOSA PER MONTAGGIO AUTOMATICO LASTRE KOMORI  
 SUCKER FOR AUTOMATIC MOUNTING OF KOMORI PLATES  
 VENTOSA PARA MONTAJE AUTOMATICO DE PLANCHAS KOMORI

CONFEZIONE DA 20 PEZZI - PACKETS OF 20 PIECES - ENVASES DE 20 PIEZAS



MISURE REALI - REAL SIZE - MEDIDAS REALES - MISURE REALI - REAL SIZE - MEDIDAS REALES - MISURE REALI - REAL SIZE - MEDIDAS REALES

**9150 BLACK**

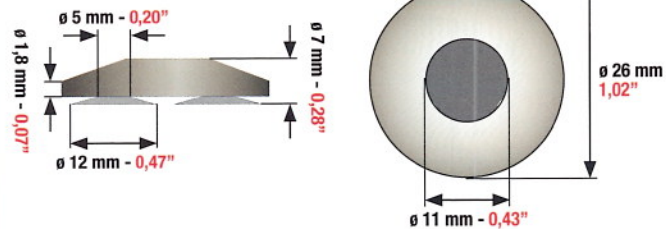

**KOMORI L28 / L29 / SX29**



MISURE REALI - REAL SIZE - MEDIDAS REALES - MISURE REALI - REAL SIZE - MEDIDAS REALES - MISURE REALI - REAL SIZE - MEDIDAS REALES

**9151 BLACK**

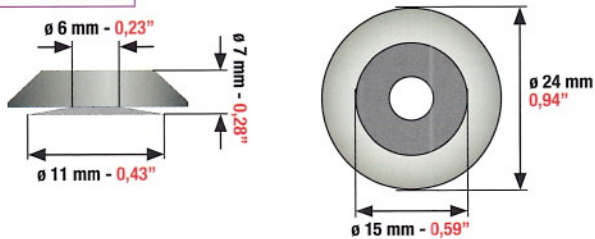

**KOMORI**



MISURE REALI - REAL SIZE - MEDIDAS REALES - MISURE REALI - REAL SIZE - MEDIDAS REALES - MISURE REALI - REAL SIZE - MEDIDAS REALES

**9152 BLACK**

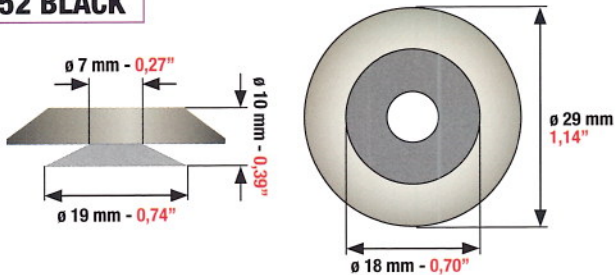

**KOMORI L40**



MISURE REALI - REAL SIZE - MEDIDAS REALES - MISURE REALI - REAL SIZE - MEDIDAS REALES - MISURE REALI - REAL SIZE - MEDIDAS REALES





**BOCCHETTA DI SOLLEVAMENTO  
LIFTING SUPPORT FOR SUCKERS  
SOPORTE DE ALZADO DE VENTOSAS**

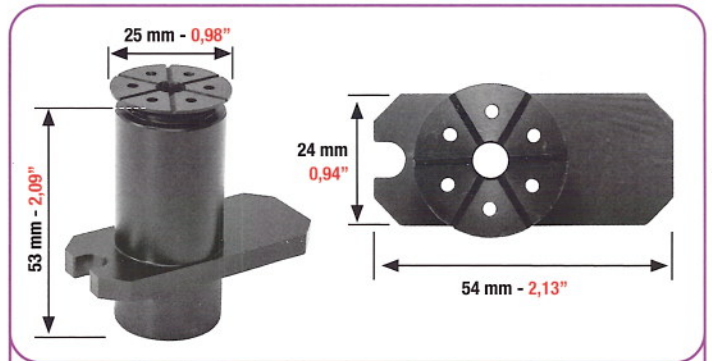

**BOCCHETTA DI SOLLEVAMENTO PER VENTOSE PER:  
LIFTING SUPPORT FOR SUCKERS FOR:  
SOPORTE DE ALZADO DE VENTOSAS PARA:**

**KOMORI GL 40**

ORDINE MINIMO 2 PEZZI MINIMUM ORDER 2 PCS PEDIDO MÍNIMO 2 PIEZAS	COMPATIBLE WITH OEM PART	CODICE - CODE - CÓDIGO
	....	<b>48114</b>

**PER CARTA - FOR PAPER - PARA PAPEL**

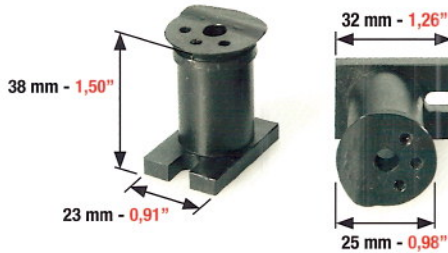

**BOCCHETTA DI SOLLEVAMENTO PER VENTOSE PER:  
LIFTING SUPPORT FOR SUCKERS FOR:  
SOPORTE DE ALZADO DE VENTOSAS PARA:**

**KOMORI LITHRONE 26**

ORDINE MINIMO 2 PEZZI MINIMUM ORDER 2 PCS PEDIDO MÍNIMO 2 PIEZAS	COMPATIBLE WITH OEM PART	CODICE - CODE - CÓDIGO
	....	<b>4824</b>

**PER CARTONE - FOR CARDBOARD - PARA CARTÓN**

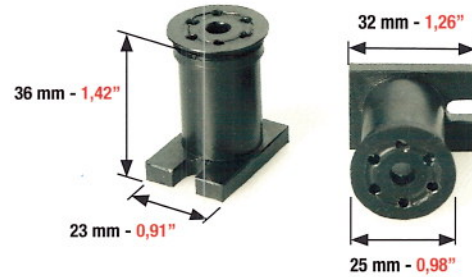

**BOCCHETTA DI SOLLEVAMENTO PER VENTOSE PER:  
LIFTING SUPPORT FOR SUCKERS FOR:  
SOPORTE DE ALZADO DE VENTOSAS PARA:**

**KOMORI LITHRONE 26**

ORDINE MINIMO 2 PEZZI MINIMUM ORDER 2 PCS PEDIDO MÍNIMO 2 PIEZAS	COMPATIBLE WITH OEM PART	CODICE - CODE - CÓDIGO
	....	<b>4825</b>

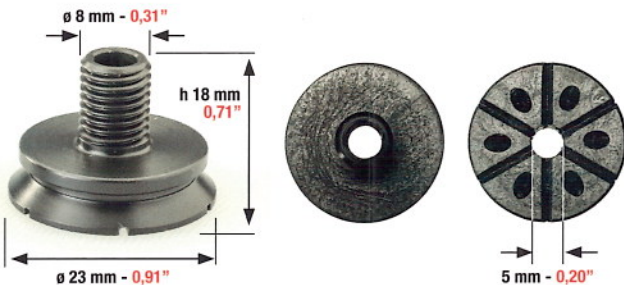

**UNIVERSAL**

**KOMORI - ALL MODELS  
FOR PAPER & CARDBOARD**

ORDINE MINIMO 2 PEZZI MINIMUM ORDER 2 PCS PEDIDO MÍNIMO 2 PIEZAS	COMPATIBLE WITH OEM PART	CODICE - CODE - CÓDIGO
	...	<b>4841</b>

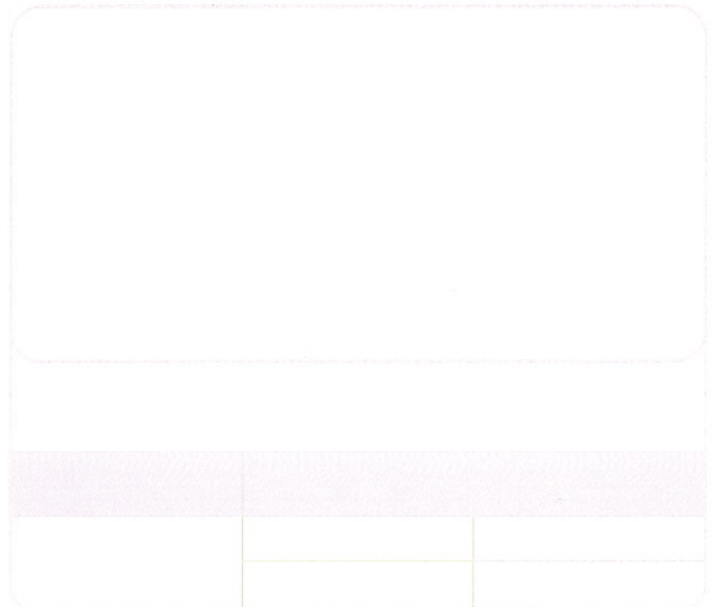





PRODOTTE CON ACCIAIO SVEDESE ORIGINALE  
 PRODUCED WITH ORIGINAL SWEDISH STEEL  
 FABRICADAS CON ACERO SUECO ORIGINAL

## LINGUETTE SEPARAFOGLIO SHEET SEPARATORS LENGÜETAS SEPARADORAS

TOP QUALITY PRODOTTE CON ACCIAIO SVEDESE ORIGINALE • PRODUCED WITH ORIGINAL SWEDISH STEEL • FABRICADAS CON ACERO SUECO ORIGINAL

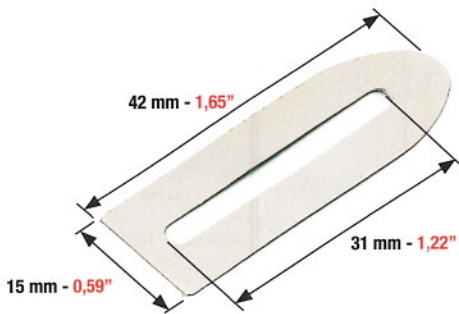

LINGUETTA SEPARAFOGLIO PER:  
 SHEET SEPARATOR FOR:  
 LENGÜETA SEPARADORA PARA:

**KOMORI**

CONF. DA 100 PZ PACKETS OF 100 PCS CONF. DE 100 PZ	CODICE - CODE - CÓDIGO	SPESSORE THICKNESS - GROSOR	
		4500	0,10 mm
	4505	0,20 mm	0,008"
	4510	0,30 mm	0,012"

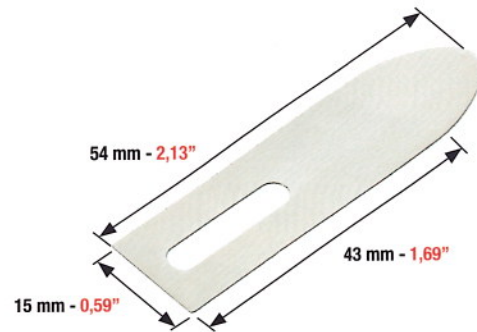

LINGUETTA SEPARAFOGLIO PER:  
 SHEET SEPARATOR FOR:  
 LENGÜETA SEPARADORA PARA:

**KOMORI**

CONF. DA 100 PZ PACKETS OF 100 PCS CONF. DE 100 PZ	CODICE - CODE - CÓDIGO	SPESSORE THICKNESS - GROSOR	
		4520	0,10 mm
	4525	0,20 mm	0,008"
	4530	0,30 mm	0,012"

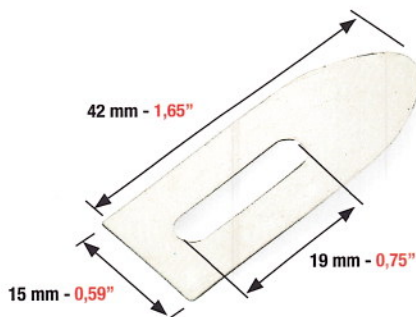

LINGUETTA SEPARAFOGLIO PER:  
 SHEET SEPARATOR FOR:  
 LENGÜETA SEPARADORA PARA:

**KOMORI**

CONF. DA 100 PZ PACKETS OF 100 PCS CONF. DE 100 PZ	CODICE - CODE - CÓDIGO	SPESSORE THICKNESS - GROSOR	
		4551	0,10 mm
	4552	0,20 mm	0,008"
	4553	0,30 mm	0,012"

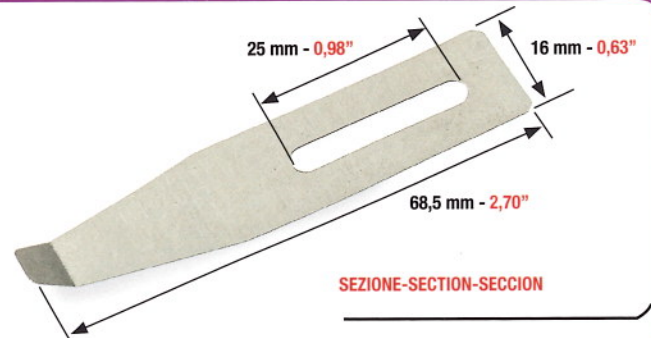

LINGUETTA SEPARAFOGLIO PER:  
 SHEET SEPARATOR FOR:  
 LENGÜETA SEPARADORA PARA:

**KOMORI SX40**

TUTTI I MODELLI - ALL MODELS - TODOS LOS MODELOS

CONF. DA 100 PZ PACKETS OF 100 PCS CONF. DE 100 PZ	CODICE - CODE - CÓDIGO	SPESSORE THICKNESS - GROSOR	
		4575	0,15mm



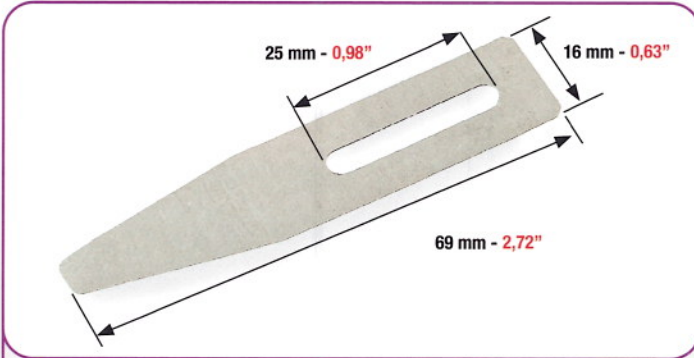

LINGUETTA SEPARAFOGLIO PER:  
SHEET SEPARATOR FOR:  
LENGÜETA SEPARADORA PARA:

**KOMORI SX40**  
TUTTI I MODELLI - ALL MODELS - TODOS LOS MODELOS

CONF. DA 100 PZ PACKETS OF 100 PCS CONF. DE 100 PZ	CODICE - CODE - CÓDIGO		SPESSORE THICKNESS - GROSOR	
		<b>4575-AA</b>		0,15 mm



LINGUETTA SEPARAFOGLIO PER:  
SHEET SEPARATOR FOR:  
LENGÜETA SEPARADORA PARA:

**KOMORI LITHRONE S SERIES**

CONF. DA 100 PZ PACKETS OF 100 PCS CONF. DE 100 PZ	CODICE - CODE - CÓDIGO		SPESSORE THICKNESS - GROSOR	
		<b>4576</b>		0,10 mm

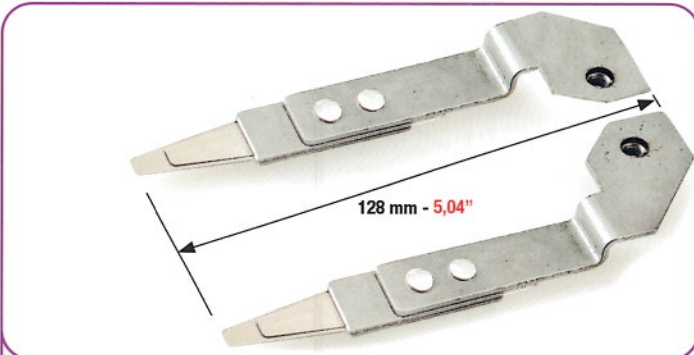

LINGUETTA SEPARAFOGLIO (DESTRA + SINISTRA) PER:  
SHEET SEPARATOR (RIGHT AND LEFT) FOR:  
LENGÜETA SEPARADORA (DERECHA + IZQUIERDA) PARA:

**KOMORI LITHRONE G 840 HPC**  
**KOMORI LITHRONE G 40** TUTTI I MODELLI - ALL MODELS

CONF. DA 100 PZ PACKETS OF 100 PCS CONF. DE 100 PZ	CODICE - CODE - CÓDIGO		SPESSORE THICKNESS - GROSOR	
		<b>4577</b>		0,15 mm

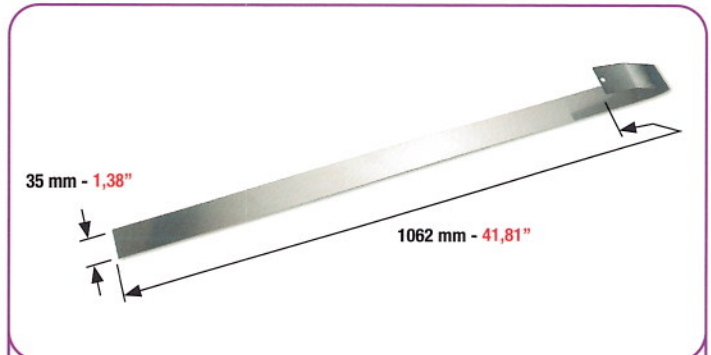

LINGUETTA IN ACCIAIO PER TAVOLA METTIFOGLIO IN "LEGNO" PER:  
STEEL TAB FOR FEEDER TABLE IN WOOD FOR:  
LENGÜETA EN ACERO PARA MESA DE MADERA INTRODUTORA DE PAPEL PARA:

**KOMORI 440**

CONF. DA 100 PZ PACKETS OF 100 PCS CONF. DE 100 PZ	CODICE - CODE - CÓDIGO		SPESSORE THICKNESS - GROSOR	
		<b>4961</b>		0,20 mm





**TOP QUALITY**  
 PRODOTTE CON ACCIAIO SVEDESE ORIGINALE  
 PRODUCED WITH ORIGINAL SWEDISH STEEL  
 FABRICADAS CON ACERO SUECO ORIGINAL

**SPAZZOLINI METTIFOGLIO  
 FEEDER BRUSHES  
 CEPILLOS PARA MARCADOR**

**TOP QUALITY** PRODOTTE CON ACCIAIO SVEDESE ORIGINALE • PRODUCED WITH ORIGINAL SWEDISH STEEL • FABRICADAS CON ACERO SUECO ORIGINAL



**SUPPORTO IN ACCIAIO  
 STEEL SUPPORT  
 SOPORTE EN ACERO**



**NERO  
 BLACK  
 NEGRO**

**SPAZZOLINO METTIFOGLIO (DESTRO + SINISTRO) PER:  
 FEEDER BRUSH (RIGHT AND LEFT) FOR:  
 CEPILLO PARA MARCADOR (DERECHO + IZQUIERDO) PARA:**

**KOMORI  
 TUTTI I MODELLI - ALL MODELS - TODOS LOS MODELOS**

ORDINE MINIMO 2 COPPIE MINIMUM ORDER 2 PAIRS PEDIDO MÍNIMO 2 PAREJAS	CODICE - CODE - CÓDIGO		
	<b>4591</b>		

**SPAZZOLINO METTIFOGLIO PER:  
 FEEDER BRUSH FOR:  
 CEPILLO PARA MARCADOR PARA:**

**KOMORI LITHRONE 440/540/640/840**

ORDINE MINIMO 2 PEZZI MINIMUM ORDER 2 PCS PEDIDO MÍNIMO 2 PIEZAS	CODICE - CODE - CÓDIGO		
	<b>4592-A SOFT</b>		

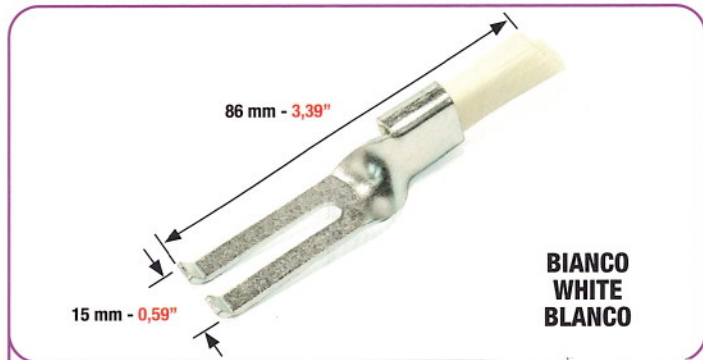

**BIANCO  
 WHITE  
 BLANCO**

**SPAZZOLINO METTIFOGGIO PER:  
 FEEDER BRUSH FOR:  
 CEPILLO PARA MARCADOR PARA:**

**KOMORI LITHRONE 440/540/640/840**

ORDINE MINIMO 2 PEZZI MINIMUM ORDER 2 PCS PEDIDO MÍNIMO 2 PIEZAS	CODICE - CODE - CÓDIGO		
	<b>4592 HARD</b>		





PRODOTTE CON ACCIAIO SVEDESE ORIGINALE  
 PRODUCED WITH ORIGINAL SWEDISH STEEL  
 FABRICADAS CON ACERO SUECO ORIGINAL



# KOMORI GUIDES



PRODOTTE CON ACCIAIO SVEDESE ORIGINALE • PRODUCED WITH ORIGINAL SWEDISH STEEL • FABRICADAS CON ACERO SUECO ORIGINAL

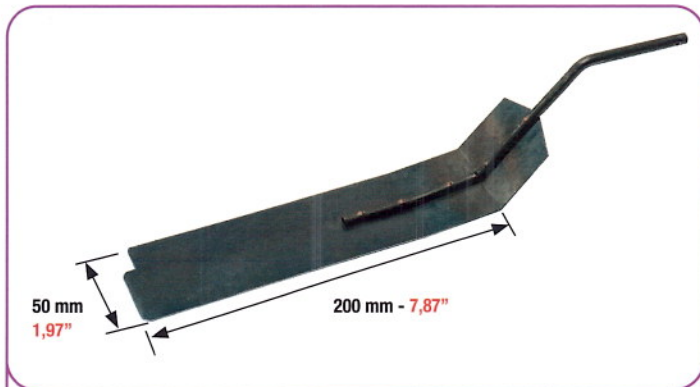

**KOMORI GUIDE**  
**KOMORI**

CODICE  
 CODE - CÓDIGO  
**4999-A**



**KOMORI GUIDE**  
**KOMORI**

CODICE  
 CODE - CÓDIGO  
**4999**





90 mm - 3,54"

COMPATIBLE WITH OEM PART:  
KOM 2746823301

CODICE  
CODE - CÓDIGO

**4976**

**KOMORI**



122 mm - 4,80"

COMPATIBLE WITH OEM PART:  
KOM 343-6800-100

CODICE  
CODE - CÓDIGO

**4977**

**KOMORI**



38 mm - 1,50"

COMPATIBLE WITH OEM PART:  
KOM 274-6821-302

CODICE  
CODE - CÓDIGO

**4978**

**KOMORI**



38 mm - 1,50"

COMPATIBLE WITH OEM PART:  
KOM 364-6800-400

CODICE  
CODE - CÓDIGO

**4978A**

**KOMORI**



110 mm - 4,33"

COMPATIBLE WITH OEM PART:  
FME 6810-401

CODICE  
CODE - CÓDIGO

**4979**

**KOMORI LITHRONE G 40**

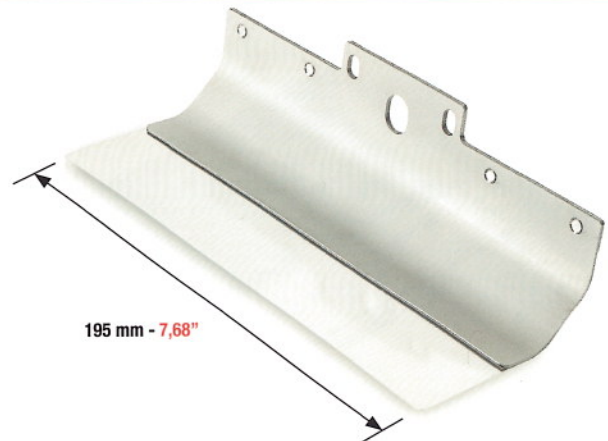

195 mm - 7,68"

COMPATIBLE WITH OEM PART:  
FME 6810-501

CODICE  
CODE - CÓDIGO

**4980**

**KOMORI LITHRONE G 40**

**4980**



+

**4979**



KIT COMPLETO COMPOSTA DA 2 GUIDE GRANDI COD. 4980 + 5 GUIDE PICCOLE COD. 4979  
COMPLETE KIT COMPOSED OF 2 LARGE GUIDES CODE 4980 + 5 SMALL GUIDES CODE 4979  
JUEGO COMPLETO DE DUE LENGÜETAS GUIA GRANDES COD. 4980 + 5 LENGÜETAS GUIA PEQUEÑAS COD. 4979

**KOMORI LITHRONE G 40**



**GUIDE PER KOMORI LITHRONE SERIE S 40**  
**GUIDE FOR KOMORI LITHRONE S 40 SERIES**  
**GUIA PARA KOMORI LITHRONE SERIE S 40**

**DX** DX = destra, right, derecha

**SX** SX = sinistra, left, izquierda

CODICE  
CODE - CÓDIGO

**4988**

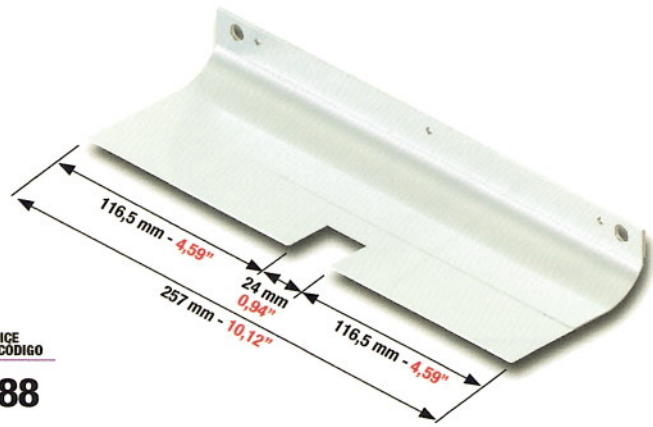

**KOMORI LITHRONE S 40**

**DX**



**SX**



**STANDARD SIZE**

**KIT COMPLETO**  
**COMPLETE KIT**  
**JUEGO COMPLETO**

CODICE  
CODE - CÓDIGO

**4983 SX + DX**

**KOMORI LITHRONE S 40**

**DX**

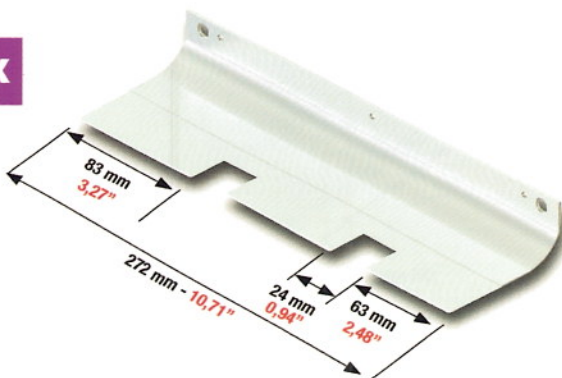

**SX**

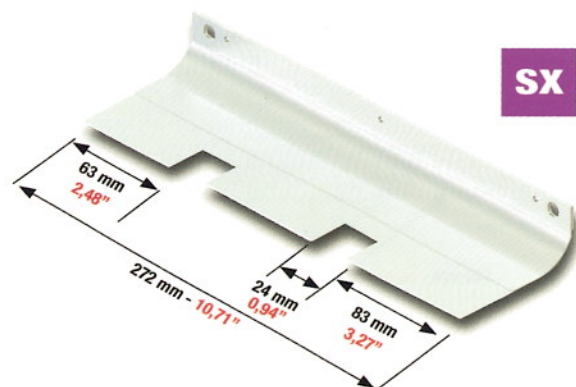

**STANDARD SIZE**

**KIT COMPLETO**  
**COMPLETE KIT**  
**JUEGO COMPLETO**

CODICE  
CODE - CÓDIGO

**4986 SX + DX**

**KOMORI LITHRONE S 40**

**4988**



+

**4983**



+

**4986**



**KIT COMPLETO COMPOSTO: 1 COD. 4988 + 1 COD. 4983 (DX+SX) + 1 COD. 4986 (DX+SX)**  
**COMPLETE KIT COMPOSED: 1 COD. 4988 + 1 COD. 4983 (DX+SX) + 1 COD. 4986 (DX+SX)**  
**JUEGO COMPLETO: 1 COD. 4988 + 1 COD. 4983 (DX+SX) + 1 COD. 4986 (DX+SX)**

**KOMORI LITHRONE S 40**



**NUOVE GUIDE PER KOMORI LITHRONE  
NEW GUIDES FOR KOMORI LITHRONE  
NUEVAS GUÍAS PARA KOMORI LITHRONE**

CODICE  
CODE - CÓDIGO  
**4990**



**KOMORI LITHRONE 40**

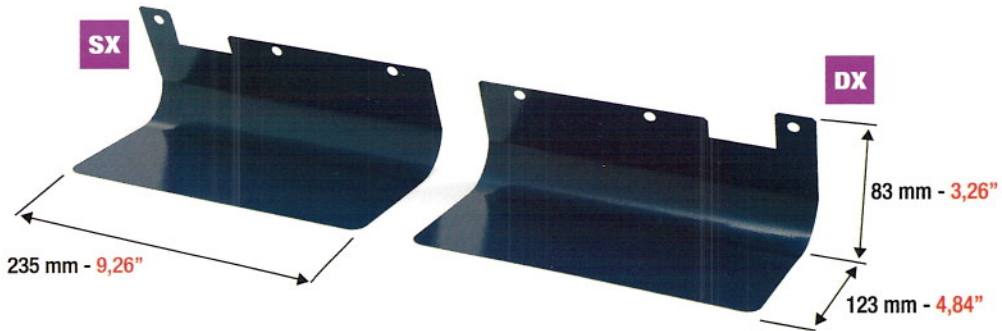

**STANDARD SIZE**

KIT COMPLETO  
COMPLETE KIT  
JUEGO COMPLETO

CODICE  
CODE - CÓDIGO  
**4990A SX + DX**

**KOMORI LITHRONE GX40RP "LED-UV" ( 10 COLOURS )**

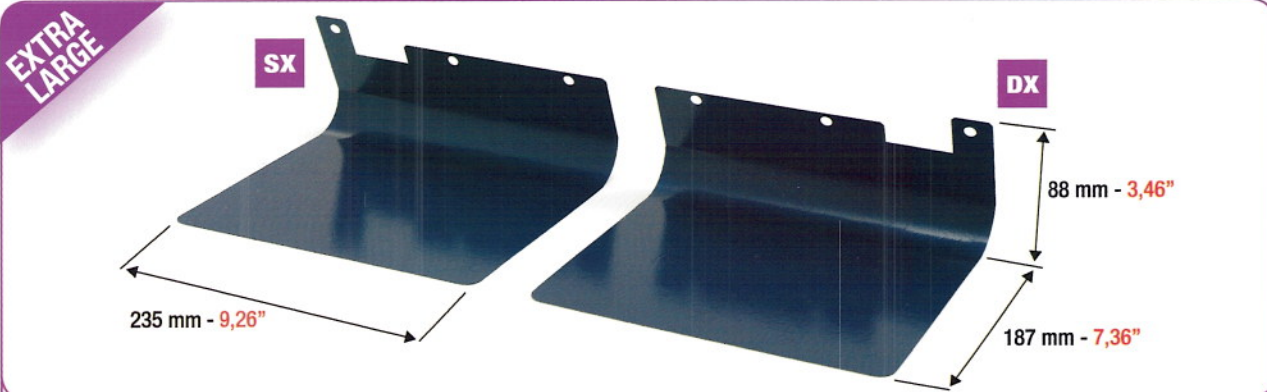

**SPECIAL SIZE  
TAMAÑO ESPECIAL**

KIT COMPLETO  
COMPLETE KIT  
JUEGO COMPLETO

CODICE  
CODE - CÓDIGO  
**4993 SX + DX**

**BIGGER SIZE  
MEDIDA AUMENTADA  
MISURA MAGGIORATA**

**KOMORI LITHRONE GX40RP "LED-UV" ( 10 COLOURS )**

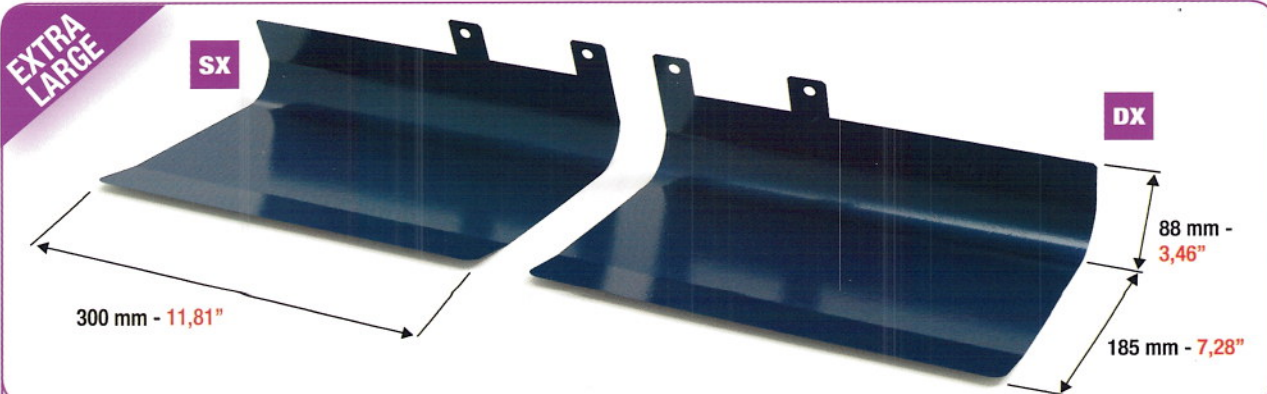

**SPECIAL SIZE  
TAMAÑO ESPECIAL**

KIT COMPLETO  
COMPLETE KIT  
JUEGO COMPLETO

CODICE  
CODE - CÓDIGO  
**4996 SX + DX**

**BIGGER SIZE  
MEDIDA AUMENTADA  
MISURA MAGGIORATA**

**KOMORI LITHRONE G40 ( 5 COLOURS ) / KOMORI LITHRONE G40P ( 8 COLOURS )**



**CINGHIE DI TRASPORTO  
FEEDER BELTS  
CORREAS DE TRANSPORTE**

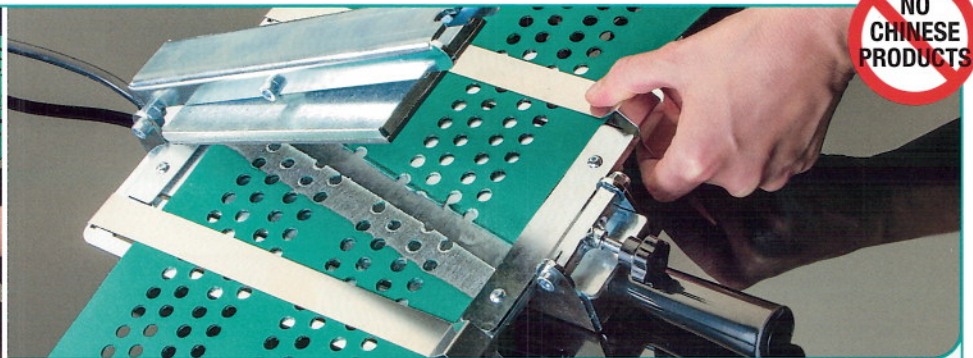
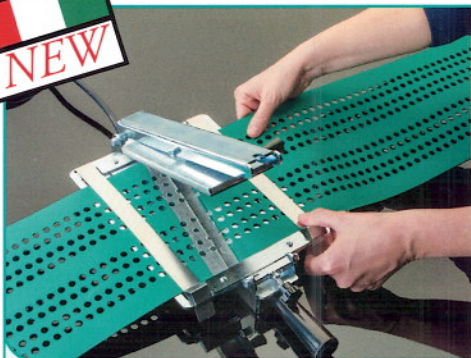
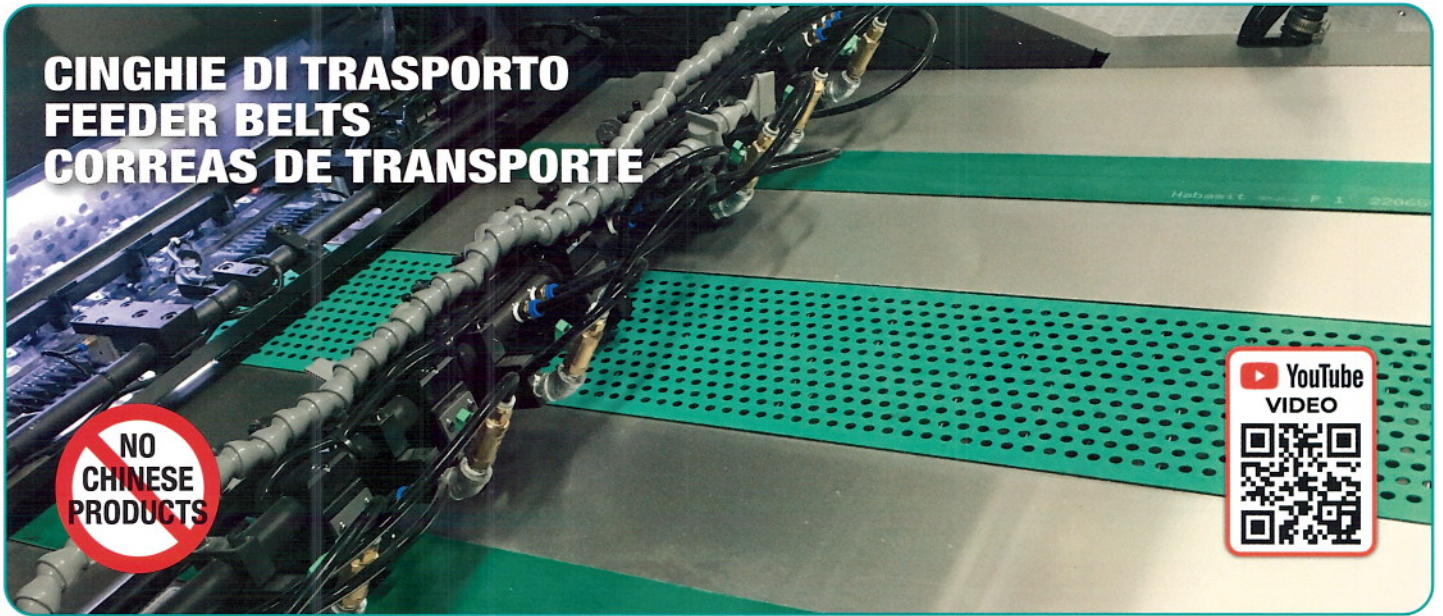

**GRANDE MACCHINA SALDATRICE PER CINGHIE DI TRASPORTO LUCE UTILE mm 230 (cod. 6206)**  
**LARGE WELDING MACHINE FOR FEEDER BELTS MAXIMUM WELDING WIDTH mm 230 (code 6206)**  
**GRANDE MÁQUINA DE SOLDAR PARA CORREAS DE TRANSPORTE MAXIMO UTIL mm 230 (código 6206)**

**LARGE**

**PRODOTTA INTERAMENTE IN ITALIA - PRODUCED ENTIRELY IN ITALY - PRODUCIDA TOTALMENTE EN ITALIA**

CERTIFICATA

CERTIFICATION

CERTIFICADA

CODICE  
CODE - CÓDIGO  
**6206**

LARGHEZZA  
WIDTH - ANCHO  
mm 230

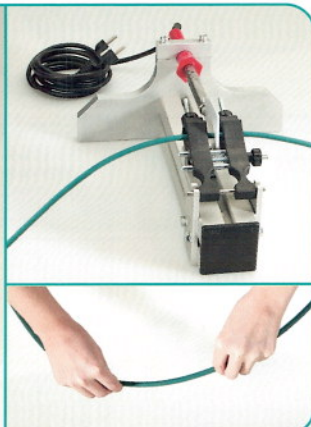

**MACCHINA SALDATRICE PER CINGHIE DI TRASPORTO TONDE**  
**WELDING MACHINE FOR ROUND FEEDER BELTS**  
**MÁQUINA DE SOLDAR PARA CORREAS DE TRANSPORTE REDONDAS**

**PRODOTTA INTERAMENTE IN ITALIA - PRODUCED ENTIRELY IN ITALY - PRODUCIDA TOTALMENTE EN ITALIA**

CERTIFICATA  
CERTIFICATION  
CERTIFICADA

CODICE  
CODE - CÓDIGO  
**6207**



**COLLA "SPECIALE" AD ALTA RESISTENZA PER CINGHIE DI TRASPORTO**  
**"SPECIAL" HIGH-RESISTANCE GLUE FOR FEEDER BELTS**  
**COLA "ESPECIAL" DE ALTA RESISTENCIA PARA CORREAS DE TRANSPORTE**

**FIXOL  
FLACONE DA 40 ML - 40 ML BOTTLE - FRASCO DE 40 ML**

CODICE - CODE - CÓDIGO  
**6201**

È vietata la riproduzione di ogni singola o parziale fotografia del presente catalogo, tutti i diritti sono riservati. - Any reproduction in whole or in part of this catalogue, is strictly prohibited. All rights reserved. - Se prohíbe terminantemente la reproducción total o parcial de cada fotografía contenida en este catálogo. Todos los derechos están reservados. ممنوع الأستساخ من كل أو بعض هذا الدليل منعاً باتاً. كل الحقوق محفوظة



**"S"**

25 mm - 0,98"

AC - CB

<b>6065</b>	1667 mm x 25 mm 65,63" x 0,98"
<b>6070</b>	1292 mm x 28 mm 50,87" x 1,10"
<b>6075</b>	1962 mm x 25 mm 74,24" x 0,98"

CINGHIA DI TRASPORTO PER METTIFOGLIO PER:  
FEEDER BELT FOR:  
CORREA DE TRANSPORTE PARA:

	CODICE CODE - CÓDIGO
<b>KOMORI LITHRONE 26</b>	<b>6065</b>
	<b>6070</b>
<b>KOMORI LITHRONE 28/428/528/628</b>	<b>6075</b>
TUTTI I MODELLI - ALL MODELS - TODOS LOS MODELOS	

**"T"**

40 mm - 1,57"

AC - CB

	2680 mm x 40 mm 105,51" x 1,57"
--	------------------------------------

CINGHIA DI TRASPORTO PER METTIFOGLIO PER:  
FEEDER BELT FOR:  
CORREA DE TRANSPORTE PARA:

**KOMORI LITHRONE 40/440/540/640/840**  
TUTTI I MODELLI - ALL MODELS - TODOS LOS MODELOS

	CODICE CODE - CÓDIGO
	<b>6064-A</b>

**"T"**

25 mm - 0,98"

AC - CB

	2680 mm x 25 mm 105,51" x 0,98"
--	------------------------------------

CINGHIA DI TRASPORTO PER METTIFOGLIO PER:  
FEEDER BELT FOR:  
CORREA DE TRANSPORTE PARA:

**KOMORI LITHRONE LS 40**  
TUTTI I MODELLI - ALL MODELS - TODOS LOS MODELOS

	CODICE CODE - CÓDIGO
	<b>6064-C</b>

**"S"**

25 mm - 0,98"

AC - CB

	2258 mm x 25 mm 88,90" x 0,98"
--	-----------------------------------

CINGHIA DI TRASPORTO PER METTIFOGLIO PER:  
FEEDER BELT FOR:  
CORREA DE TRANSPORTE PARA:

**KOMORI LITHRONE 40/440/540/640/840**  
TUTTI I MODELLI - ALL MODELS - TODOS LOS MODELOS

	CODICE CODE - CÓDIGO
	<b>6080</b>

**"T"**

90 mm - 3,54"

AC - CB

	2680 mm x 90 mm 105,51" x 3,54"
--	------------------------------------

CINGHIA DI TRASPORTO PER METTIFOGLIO PER:  
FEEDER BELT FOR:  
CORREA DE TRANSPORTE PARA:

**KOMORI LITHRONE 40/440/540/640/840**  
TUTTI I MODELLI - ALL MODELS - TODOS LOS MODELOS

<b>GUJ-1311-6S0</b>	CODICE CODE - CÓDIGO
	<b>6064</b>

**"T"**

220 mm - 8,66"

AC - CB

	2860 mm x 220 mm 112,60" x 86,61"
--	--------------------------------------

CINGHIA DI TRASPORTO PER METTIFOGLIO PER:  
FEEDER BELT FOR:  
CORREA DE TRANSPORTE PARA:

**KOMORI LITHRONE GL 40 SERIES**  
TUTTI I MODELLI - ALL MODELS - TODOS LOS MODELOS

	CODICE CODE - CÓDIGO
	<b>6064-B</b>





**RUOTE DI TRASPORTO PER SEZIONE METTIFOGLIO  
FEEDER WHEELS  
RUEDAS DE TRANSPORTE PARA MARCADOR**

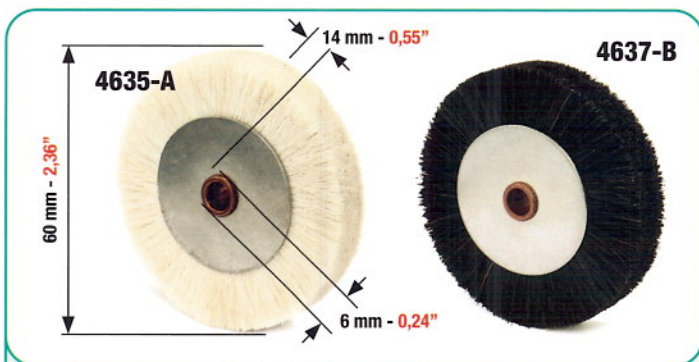

**BIANCA - WHITE - BLANCO  
CARTA - PAPER - PAPEL**

**NERA - BLACK - NEGRO  
CARTONE - CARDBOARD - CARTON**

**KOMORI  
TUTTI I MODELLI - ALL MODELS - TODOS LOS MODELOS**

ORDINE MINIMO 2 PZ / CODICE  
MINIMUM ORDER 2 PCS / CODE  
PEDIDO MÍNIMO 2 PZ / CÓDIGO

CODICE  
CODE - CÓDIGO

**4635-A**

CODICE  
CODE - CÓDIGO

**4637-B**

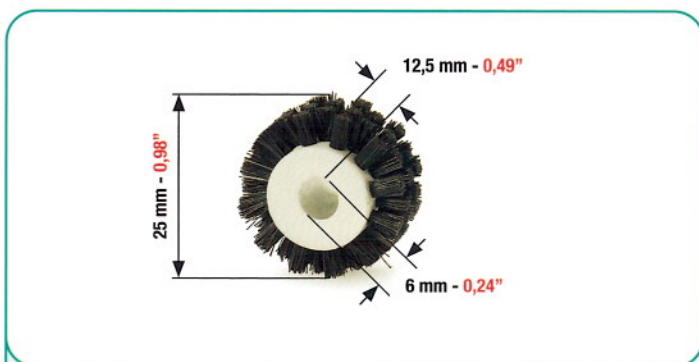

**RUOTA NERA A SPAZZOLA PER:  
BLACK BRUSH WHEEL FOR:  
RUEDA DE CEPILLO NEGRO PARA:**

**KOMORI LITHRONE S40  
TUTTI I MODELLI - ALL MODELS - TODOS LOS MODELOS**

ORDINE MINIMO 2 PEZZI  
MINIMUM ORDER 2 PCS  
PEDIDO MÍNIMO 2 PIEZAS

CODICE  
CODE - CÓDIGO

**4632**

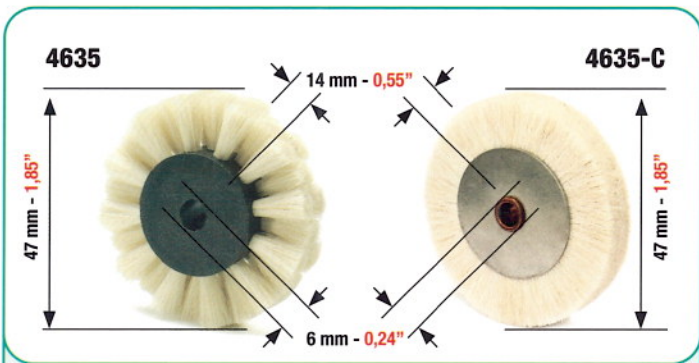

**RUOTA BIANCA A SPAZZOLA PER CARTA PER:  
WHITE BRUSH WHEEL FOR PAPER FOR:  
RUEDA DE CEPILLO BLANCO PARA PAPEL PARA:**

**KOMORI  
TUTTI I MODELLI - ALL MODELS - TODOS LOS MODELOS**

ORDINE MINIMO 2 PZ / CODICE  
MINIMUM ORDER 2 PCS / CODE  
PEDIDO MÍNIMO 2 PZ / CÓDIGO

CODICE  
CODE - CÓDIGO

**4635**

CODICE  
CODE - CÓDIGO

**4635-C**

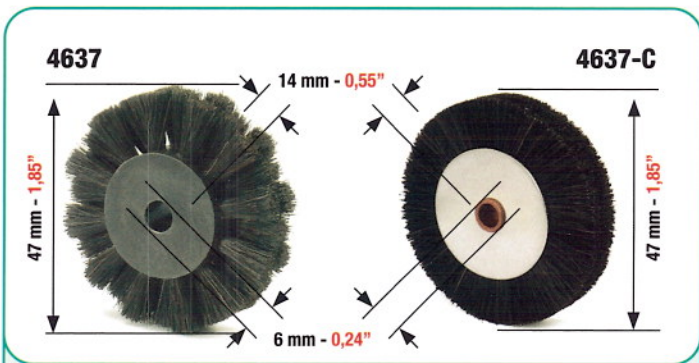

**RUOTA NERA A SPAZZOLA PER CARTONE PER:  
BLACK BRUSH WHEEL FOR CARDBOARD FOR:  
RUEDA DE CEPILLO NEGRO PARA CARTÓN PARA:**

**KOMORI  
TUTTI I MODELLI - ALL MODELS - TODOS LOS MODELOS**

ORDINE MINIMO 2 PZ / CODICE  
MINIMUM ORDER 2 PCS / CODE  
PEDIDO MÍNIMO 2 PZ / CÓDIGO

CODICE  
CODE - CÓDIGO

**4637**

CODICE  
CODE - CÓDIGO

**4637-C**



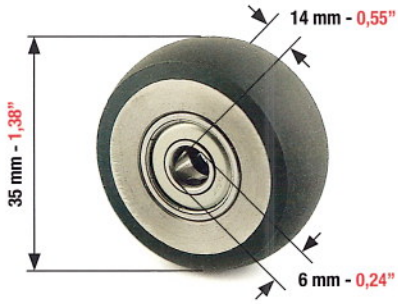

RUOTA DI TRASPORTO IN GOMMA COMPLETA DI CUSCINETTO PER:  
RUBBER WHEEL COMPLETE WITH BEARING FOR:  
RUEDA DE TRANSPORTE EN GOMA CON RODAMIENTO PARA:

**KOMORI 40/440/540/640/840**

TUTTI I MODELLI - ALL MODELS - TODOS LOS MODELOS

ORDINE MINIMO 2 PEZZI  
MINIMUM ORDER 2 PCS  
PEDIDO MÍNIMO 2 PIEZAS

CODICE  
CODE - CÓDIGO

**4631**

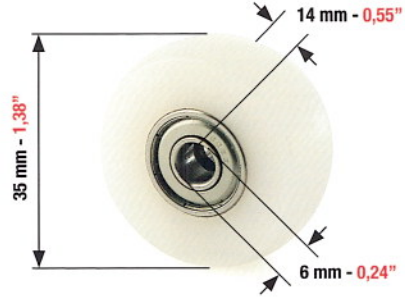

RUOTA DI TRASPORTO IN NYLON COMPLETA DI CUSCINETTO PER:  
NYLON WHEEL COMPLETE WITH BEARING FOR:  
RUEDA DE TRANSPORTE EN NYLON CON RODAMIENTO PARA:

**KOMORI 40/440/540/640/840**

TUTTI I MODELLI - ALL MODELS - TODOS LOS MODELOS

CODICE  
CODE - CÓDIGO

**4629**

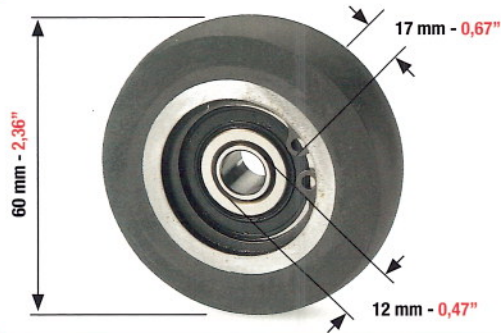

RUOTA DI TRASPORTO IN GOMMA COMPLETA DI CUSCINETTO PER:  
RUBBER WHEEL COMPLETE WITH BEARING FOR:  
RUEDA DE TRANSPORTE EN GOMA CON RODAMIENTO PARA:

**KOMORI LITHRONE 40 - S SERIES - G SERIES**

TUTTI I MODELLI - ALL MODELS - TODOS LOS MODELOS

CODICE  
CODE - CÓDIGO

**4645**

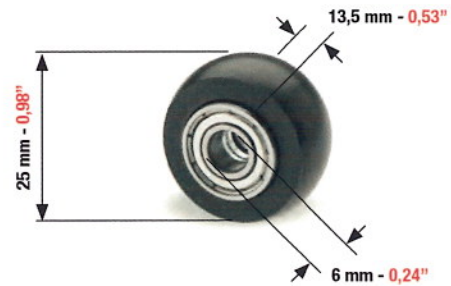

RUOTA ESTERNA IN GOMMA PER INSERIMENTO LASTRA PER:  
EXTERNAL RUBBER WHEEL FOR PLATE INSERTION FOR:  
RUEDA EXTERNA EN GOMA PARA INSERIMENTO PLANCHA PARA:

**KOMORI LITHRONE G 40**

(COMPATIBLE WITH OEM PART: CA1-0948-P00)

CODICE  
CODE - CÓDIGO

**4646**

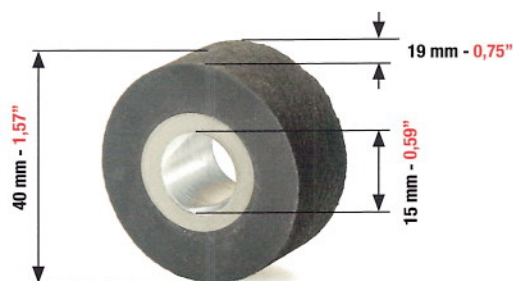

RUOTA IN GOMMA PER TENDILASTRA PER:  
RUBBER WHEEL FOR PLATE INSERTION FOR:  
RUEDA EN GOMA PARA INSERIMENTO PLANCHA PARA:

**KOMORI 40/440/540/640/840**

TUTTI I MODELLI - ALL MODELS - TODOS LOS MODELOS

21 PZ PER OGNI UNITÀ DI STAMPA  
21 PCS FOR EACH PRESS ELEMENT  
21 PZ PARA CADA CUERPO  
DE IMPRESION

CODICE  
CODE - CÓDIGO

**4629-A**

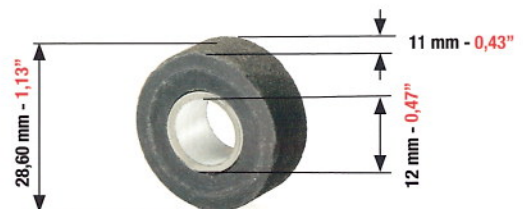

RUOTA ESTERNA IN GOMMA PER INSERIMENTO LASTRA PER:  
EXTERNAL RUBBER WHEEL FOR PLATE INSERTION FOR:  
RUEDA EXTERNA EN GOMA PARA INSERIMENTO PLANCHA PARA:

**KOMORI 40/440/540/640/840**

TUTTI I MODELLI - ALL MODELS - TODOS LOS MODELOS

6 PZ PER OGNI UNITÀ DI STAMPA  
6 PCS FOR EACH PRESS ELEMENT  
6 PZ PARA CADA CUERPO  
DE IMPRESION

CODICE  
CODE - CÓDIGO

**4629-B**



Guaranteeing a good recirculation...



...is like preserving  
your own ecosystem.

For over 20 years, our filters have been guaranteeing a superior level of filtration and consequently a longer duration of the fountain water. Longer life for the water generates the lowest possible waste.





# MAGIC FILTER PLUS

**FILTRI DI RICIRCOLO**  
**RECIRCULATION FILTERS**  
**FILTROS PARA RECIRCULADORES**

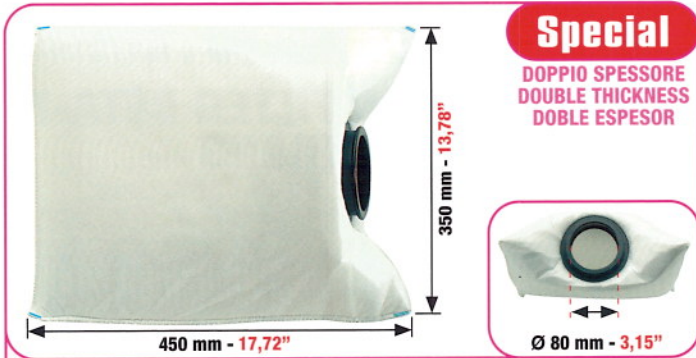

**Special**

DOPPIO SPESSORE  
 DOUBLE THICKNESS  
 DOBLE ESPESOR

Ø 80 mm - 3,15"

**TECHNOTRANS**

ORDINE MINIMO 2 PEZZI  
 MINIMUM ORDER 2 PCS  
 PEDIDO MINIMO 2 PIEZAS

CODICE - CODE - CÓDIGO

**10000**

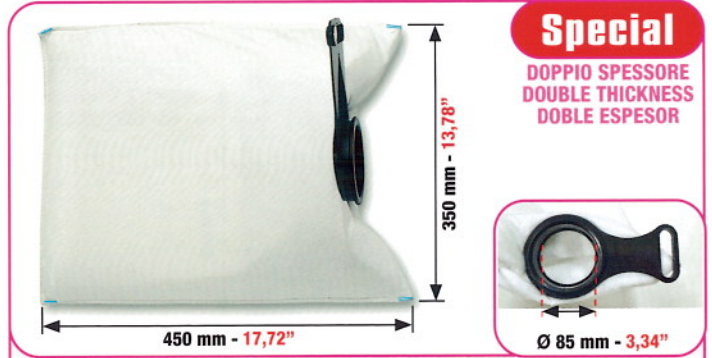

**Special**

DOPPIO SPESSORE  
 DOUBLE THICKNESS  
 DOBLE ESPESOR

Ø 85 mm - 3,34"

**TECHNOTRANS**

ORDINE MINIMO 2 PEZZI  
 MINIMUM ORDER 2 PCS  
 PEDIDO MINIMO 2 PIEZAS

CODICE - CODE - CÓDIGO

**10040**

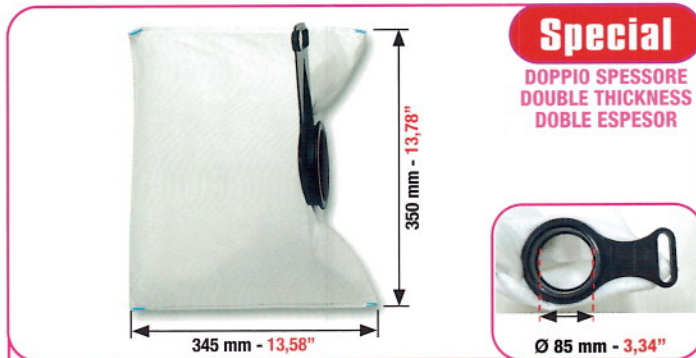

**Special**

DOPPIO SPESSORE  
 DOUBLE THICKNESS  
 DOBLE ESPESOR

Ø 85 mm - 3,34"

**TECHNOTRANS**

ORDINE MINIMO 2 PEZZI  
 MINIMUM ORDER 2 PCS  
 PEDIDO MINIMO 2 PIEZAS

CODICE - CODE - CÓDIGO

**10039**

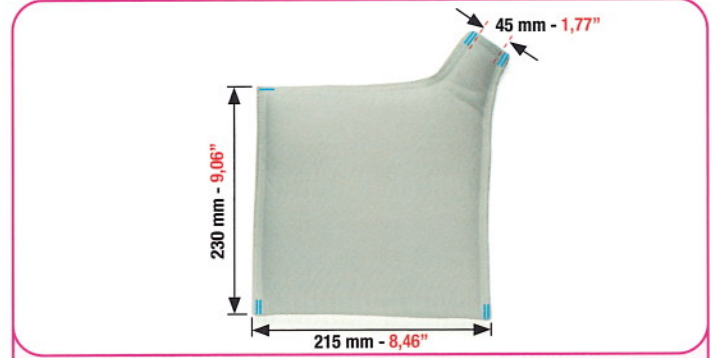

**TECHNOTRANS**

ORDINE MINIMO 2 PEZZI  
 MINIMUM ORDER 2 PCS  
 PEDIDO MINIMO 2 PIEZAS

CODICE - CODE - CÓDIGO

**10002**



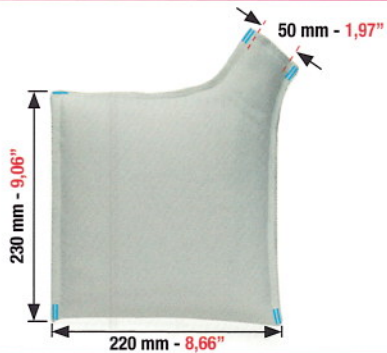

### TECHNOTRANS

ORDINE MINIMO 2 PEZZI  
MINIMUM ORDER 2 PCS  
PEDIDO MINIMO 2 PIEZAS

CODICE - CODE - CÓDIGO

**10004**



### CREMOPLAST - AQUAPRESS

ORDINE MINIMO 2 PEZZI  
MINIMUM ORDER 2 PCS  
PEDIDO MINIMO 2 PIEZAS

CODICE - CODE - CÓDIGO

**10009**

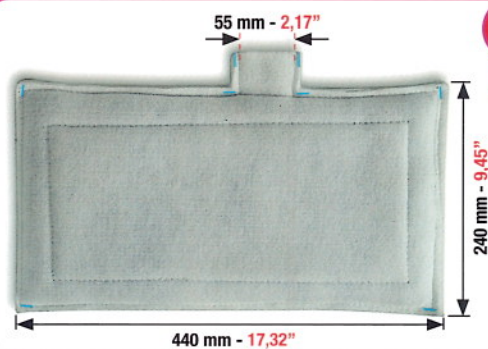

**Special**

DOPPIO SPESSORE  
DOUBLE THICKNESS  
ESPESOR DOBLE

### KOMORI LITHRONE 40/440/540/640/840 MG ELECTRIC - MOD. OPTIMA

ORDINE MINIMO 2 PEZZI  
MINIMUM ORDER 2 PCS  
PEDIDO MINIMO 2 PIEZAS

CODICE - CODE - CÓDIGO

**10030**

### NOVITÀ - NEW - NUEVO . NOVITÀ RECIRCULATION FILTER BETA-F TECHNOTRANS



CODICE - CODE - CÓDIGO

**10098**

# MAGIC OIL FILTER.®



MAGIC FILTER PLUS



**FatVampire**  
SORB

PULIZIA E SICUREZZA - CLEANLINESS AND SAFETY  
LIMPIEZA Y SEGURIDAD

ORDINE MINIMO 4 PEZZI  
MINIMUM ORDER 4 PCS  
PEDIDO MINIMO 4 PIEZAS

CODICE - CODE - CÓDIGO

**10048**



**AN OCEAN OF OILY RESIDUES  
IN THE FOUNTAIN SYSTEM ?**

**FatVampire<sup>®</sup>**  
**FOUNTAIN**

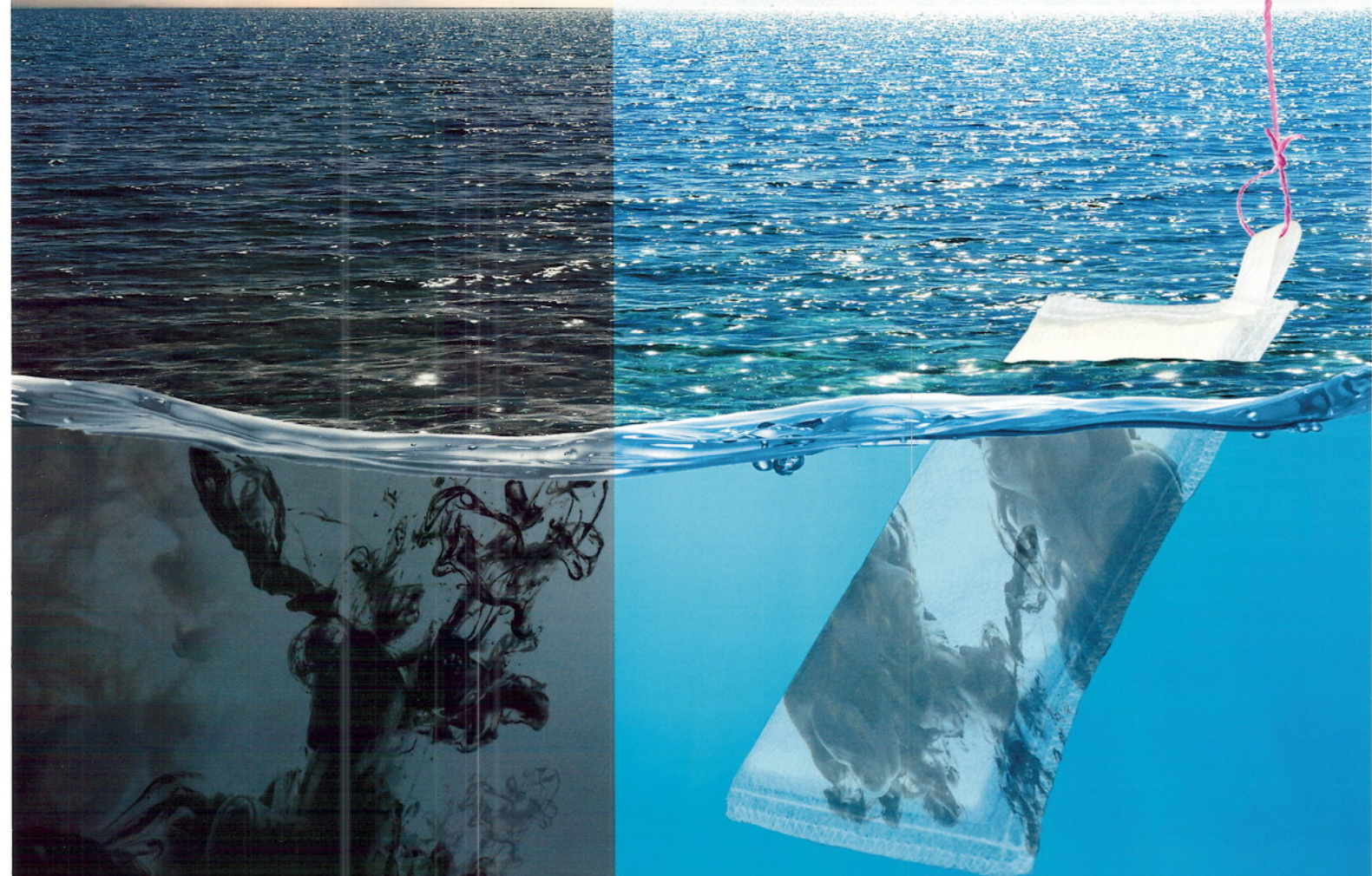

**FAT VAMPIRE**  
**absorbs all those oily ink residues present  
in the water reservoirs of fountain  
recirculating systems.**



**CODICE - CODE - CODIGO**

**10045**

**ORDINE MINIMO 4 PEZZI  
MINIMUM ORDER 4 PCS  
PEDIDO MINIMO 4 PIEZAS**



# MAGIC liquid FILTER



## SPECIALE TESSUTO DI FILTRAGGIO PER VASCHE DI RIFLUSSO DEGLI IMPIANTI DI BAGNATURA SPECIAL FILTERING NET FOR WATER RESERVOIRS OF FOUNTAIN RECIRCULATING SYSTEMS TEJIDO FILTRANTE ESPECIAL PARA TANQUES DE REFLUJO DE SISTEMAS DE MOJADO

 **MAGIC FILTER LIQUID**  
"HIGH FILTRATION" è uno speciale materassino per filtraggio, addensato termicamente da un lato, appositamente realizzato per le vasche di riflusso degli impianti di bagnatura per la depurazione dell'acqua.

 **MAGIC FILTER LIQUID**  
"HIGH FILTRATION" is a special filter mat composed of thermally compressed fleece layers, specially developed for the water reservoirs of fountain recirculating systems.

 **MAGIC FILTER LIQUID**  
"HIGH FILTRATION" es una colchoneta filtradora especial, condensada témicamente de un lado, expresamente realizada para el tanque de reflujo del sistema de mojado, para la depuración del agua.



### MISURE STANDARD - STANDARD SIZES - TAMAÑOS ESTÁNDAR

COD.	mm	inches
10385	115 X 370	4.53" X 14.57"
10390	140 X 380	5.51" X 14.96"
10400	150 X 340	5.91" X 13.39"
10410	150 X 460	5.91" X 18.11"
10415	160 X 250	6.30" X 9.84"
10416	160 X 260	6.30" X 10.24"
10417	170 X 170	6.69" X 6.69"
10421	170 X 260	6.69" X 10.24"
10418	180 X 180	7.09" X 7.09"
10420	180 X 280	7.09" X 11.02"
10425	180 X 480	7.09" X 18.90"
10430	200 X 280	7.87" X 11.02"
10440	200 X 320	7.87" X 12.60"
10450	200 X 440	7.87" X 17.32"
10453	220 X 270	8.66" X 10.63"
10457	220 X 330	8.66" X 12.99"
10459	230 X 230	9.06" X 9.06"
10465	230 X 460	9.06" X 18.11"
10508	240 X 240	9.45" X 9.45"

COD.	mm	inches
10461	240 X 450	9.45" X 17.72"
10468	240 X 480	9.45" X 18.90"
10455	250 X 260	9.84" X 10.24"
10475	250 X 290	9.84" X 11.42"
10460	250 X 300	9.84" X 11.81"
10472	250 X 350	9.84" X 13.78"
10470	250 X 470	9.84" X 18.50"
10480	250 X 670	9.84" X 26.38"
10471	250 X 750	9.84" X 29.53"
10489	260 X 475	10.24" X 18.70"
10483	270 X 310	10.63" X 12.20"
10486	270 X 780	10.63" X 30.71"
10487	300 X 400	11.81" X 15.75"
10481	300 X 460	11.81" X 18.11"
10485	300 X 490	11.81" X 19.29"
10488	300 X 640	11.81" X 25.20"
10490	305 X 1150	12.01" X 45.28"
10500	315 X 660	12.40" X 25.98"
10501	315 X 1080	12.40" X 42.52"

COD.	mm	inches
10502	315 X 1150	12.40" X 45.28"
10504	330 X 1080	12.99" X 42.52"
10482	350 X 500	13.78" X 19.69"
10507	360 X 360	14.17" X 14.17"
10509	360 X 580	14.17" X 22.83"
10503	380 X 760	14.96" X 29.92"
10506	390 X 880	15.35" X 34.65"
10505	390 X 1940	15.35" X 76.38"
10510	400 X 400	15.75" X 15.75"
10515	400 X 540	15.75" X 21.26"
10520	400 X 900	15.75" X 35.43"
10525	420 X 480	16.54" X 18.90"
10527	430 X 430	16.93" X 16.93"
10528	440 X 600	17.32" X 23.62"
10529	450 X 1550	17.72" X 61.02"
10532	500 X 500	19.69" X 19.69"
10530	500 X 750	19.69" X 29.53"

PUÒ ESSERE FORNITO IN QUALSIASI MISURA SPECIALE VENGA SPECIFICATAMENTE RICHIESTA  
CAN ALSO BE SUPPLIED IN ANY SPECIAL SIZE REQUIRED / SE PUEDE SUMINISTRAR EN CUALQUIER TAMAÑO ESPECIAL BAJO PEDIDO



# MAGIC Air FILTER

**PER SISTEMI D'ARIA / FOR AIR SYSTEMS  
PARA SISTEMAS DE AIRE:  
UTA – GABINE – COMPRESSORS**

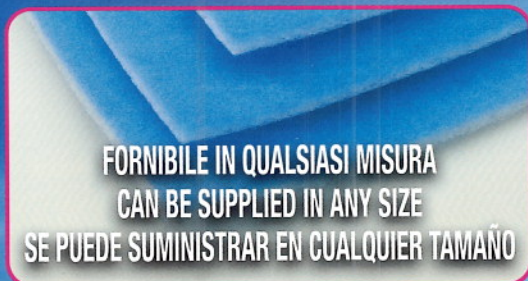

**FORNIBILE IN QUALSIASI MISURA  
CAN BE SUPPLIED IN ANY SIZE  
SE PUEDE SUMINISTRAR EN CUALQUIER TAMAÑO**

**RICHIEDETE IL LISTINO PREZZI  
DELL'INTERA GAMMA "MAGIC FILTER AIR".  
REQUEST THE PRICE LIST FOR THE FULL  
RANGE OF "MAGIC AIR FILTERS".  
SOLICITE LA LISTA DE PRECIOS PARA  
LA GAMA COMPLETA DE "MAGIC AIR FILTERS".**

<b>CODICE CODE / CÓDIGO</b>	<b>MISURE / SIZES TAMAÑOS "STANDARD"</b>
10104	160 MM X 340 MM
10103	200 MM X 440 MM
10105	210 MM X 210 MM
10106	235 MM X 550 MM
10107	285 MM X 285 MM
10108	275 MM X 750 MM
10110	510 MM X 1210 MM
10111	420 MM X 1100 MM
10112	520 MM X 1300 MM
10115	580 MM X 1440 MM
10118	590 MM X 1220 MM
10125	670 MM X 1470 MM
10130	680 MM X 1440 MM
10135	700 MM X 900 MM
10140	720 MM X 1420 MM
10143	870 MM X 1300 MM
10150	1100 MM X 1300 MM

## **FILTRI D'ARIA PER SISTEMI BALDWIN • AIR FILTERS FOR BALDWIN SYSTEMS FILTROS DE AIRE PARA SISTEMAS BALDWIN**



**CODICE  
CODE  
CÓDIGO** **10180**  
**OEM: 26090.99**



**CODICE  
CODE  
CÓDIGO** **10181**  
**OEM: 7352751**

## **FILTRI PER ASPIRAZIONE GRUPPI MACINAZIONE E CALAMAIO PER KOMORI H-UV • LED-UV AIR FILTERS FOR GRINDING GROUP AND INK DUCT FOR KOMORI H-UV • LED-UV FILTROS PARA ASPIRACION GRUPOS TRITURADO Y TINTERO PARA KOMORI H-UV • LED-UV**



<b>CODICE CODE CÓDIGO</b>	<b>SPESSORE/ THICKNESS/ESPEJOR IN MM</b>	<b>MISURA SIZE MEDIDA MM</b>
10163	15	120 x 365
10164	15	120 x 390
10166	15	180 x 180
10169	15	125 x 915
10172	15	125 x 1045
10175	15	282 x 1150



# CYLINDER JACKET PLANET

THE MOST COMPLETE PROGRAMME OF JACKETS THAT HAS EVER BEEN PROPOSED

IMPRESSION  
CYLINDER  
JACKETS  
CERAMIC TREATED  
AND  
UNTREATED



TRANSFER  
CYLINDER JACKETS  
TREATED AND UNTREATED



PROTECTIVE CYLINDER  
JACKETS  
AND  
DIE CUTTING JACKETS

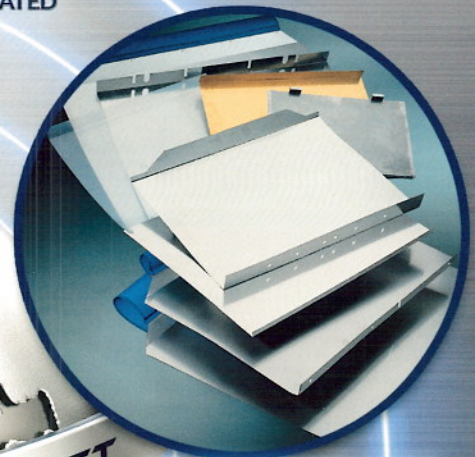

SUPER FILM  
JACKETS  
AND  
TRANSFER  
CYLINDER  
JACKETS



SPEED NET  
FOR TRANSFER CYLINDER  
AND  
UNDER NET JACKETS

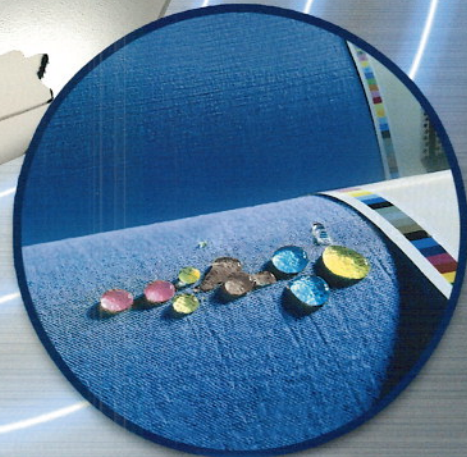

CYLINDER JACKET PLANET



TOP QUALITY



# ROYAL PRESS®

CAMICIE DI PROTEZIONE DEI CILINDRI PER QUALSIASI MACCHINA DA STAMPA OFFSET  
 CYLINDER JACKETS FOR ALL OFFSET PRINTING PRESSES  
 CAMISA DE PROTECCION DEL CILINDRO PARA CUALQUIER MÁQUINA DE IMPRESIÓN OFFSET

## CAMICIE NON TRATTATE - UNTREATED CYLINDER JACKETS CAMISAS NO TRATADAS

CODICE CODE CÓDIGO	PRESS MODEL	MACHINE SIZE	THICKNESS IN MM
4320	SPRINT 26	46 x 48	0,30
4325*	SPRINT 26	46 x 48	0,50
4330	SPRINT 28	52 x 72	0,30
4335*	SPRINT 28	52 x 72	0,50
4336	SPICA 29 (774 x 621)	52 x 74	0,30
4340	L40 RP (Part N°481-3247-0,22)	72 x 104	0,50
4345	LS40SP - G40	74 x 104	0,35
*PLASTIC			

**CODE 27.20926**

**SCHWEGO DAMP 8174**

SPECIAL CLEANER FOR ANTI-MARKING MATERIALS



1 BOX CONTAINS  
 12 BOTTLES OF 1 LT. EACH

Il primo "esclusivo" prodotto di lavaggio universale per la pulizia di tutte le camicie con superficie trattata montate sui cilindri di pressione e di trasferimento.

The first "exclusive" universal wash product for the cleaning of all cylinder jackets with a treated surface used on the impression and transfer cylinders.

El primer y "exclusivo" producto de lavado universal para la limpieza de todas las camisas con tratamiento para cilindros de presion y de transferencia.

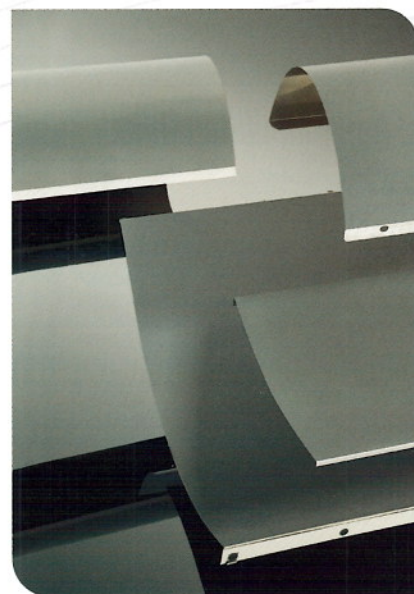

PER MAGGIORI INFORMAZIONI, FATE RICHIESTA DEL LISTINO PREZZI RELATIVO ALLE NOSTRE "ROYAL PRESS®"

FOR FURTHER DETAILS, PLEASE REQUEST OUR PRICE LIST FOR "ROYAL PRESS®"

PARA OBTENER UNA MAYOR INFORMACION, CONSULTE NUESTRA TARIFA DE PRECIOS CORRESPONDIENTE A NUESTRAS "ROYAL PRESS®"





# CERAMIC TREATED IMPRESSION CYLINDER JACKETS

## CAMICIE PER CILINDRI DI PRESSIONE TRATTATE IN CERAMICA

### CAMISAS CON TRATAMIENTO CERAMICO PARA CILINDROS DE PRESION

#### IMPORTANT - IMPORTANTE - IMPORTANTE:

- TWO JACKETS ARE NEEDED FOR EACH CYLINDER IN KOMORI PRESSES
- NELLE MACCHINE KOMORI SONO NECESSARIE DUE CAMICIE PER OGNI CILINDRO
- EN LAS MAQUINAS KOMORI SE REQUIEREN DOS CAMISAS PARA CADA CILINDRO

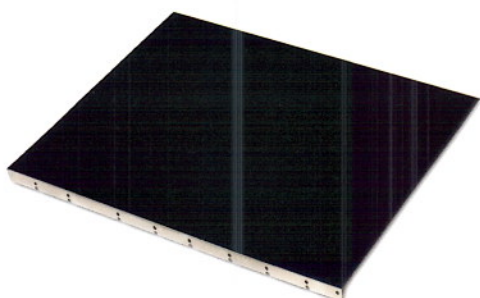

#### ATTENZIONE - ATTENTION - ATENCIÓN

- WE RECOMMEND THE REPLACEMENT OF THE IMPRESSION CYLINDER JACKETS ON ALL THE CYLINDERS AT THE SAME TIME.
- CONSIGLIAMO LA SOSTITUZIONE DELLE CAMICIE PER I CILINDRI DI PRESSIONE SU TUTTI I CILINDRI CONTEMPORANEAMENTE.
- RECOMENDAMOS REEMPLAZAR LAS CAMISAS DE LOS CILINDROS DE PRESIÓN EN TODOS LOS CILINDROS AL MISMO TIEMPO.

● Impression ● Blanket ● Transfer

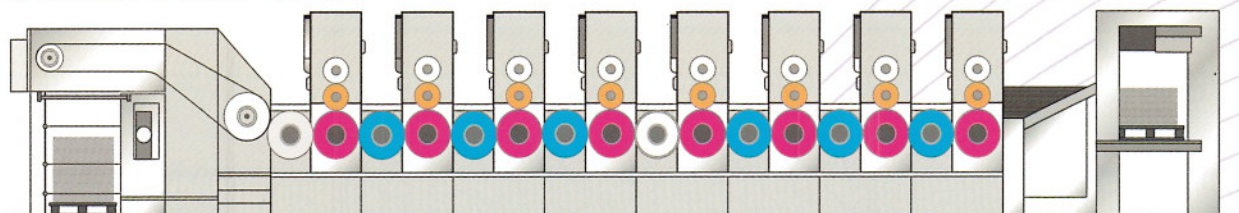

#### KEY: NT = NO TREATMENT - NESSUN TRATTAMENTO - SIN TRATAMIENTO

CODICE CODE CÓDIGO	PRESS MODEL	THICKNESS IN MM	BASE DIM (L X W)	OEM PART NUMBER	NOTE
11386	L40SP	0,411 - 0,420	1030 x 805	742.3202.401	TOP (UPPER)
11387	L40SP	0,411 - 0,420	1030 x 805	742.3251.301	BOTTOM (LOWER)
11386 NT	L40SP	0,30	1030 x 805	742.3202.500	PLAIN STEEL / NT
11390	LS40SP	0,411 - 0,420	1030 x 805	GFH.3200.201	TOP (UPPER)
11391	LS40SP	0,411 - 0,420	1030 x 805	714.3250.600	BOTTOM (LOWER)
11390 NT	LS40SP / G40	0,35	1030 x 805	714.3200.800	PLAIN STEEL / NT
11394	L40P	0,411 - 0,420	1030 x 805	IGS.3234.112	10 HOLES
11394 NT	L40P	0,30	1030 x 805	IGS.3234.022	ETCH LINED / NT
11395	LS40SP / G40P	0,411 - 0,420	1030 x 805	GFH.3200.201	10 HOLES
11400	L26P	0,365 - 0,370		SFU.3305.202	
11400 NT	L26P	0,30		SFU.3202.200	PLAIN STEEL / NT
11405	L28P	0,365 - 0,370		SFV.3303.200	
11405 NT	L28P	0,30		SFV.3202.201	ETCH LINED / NT
11408	LS29P	0,360 - 0,380	760 PITCH 52MM	834.3200.301	52MM PITCH/W:760
11410	LS29P	0,360 - 0,380	750 PITCH 50MM	834.3200.401	50MM PITCH/W:750
11385	SPICA 29	0,411 - 0,420		345.3500.803	
11396	L44SP	0,411 - 0,420	1130 x 919	742.3202.403	TOP (UPPER)
11397	L44SP	0,411 - 0,420	1130 x 919	752.3225.903	BOTTOM (LOWER)
11398	LS44SP	0,411 - 0,420	1150 x 888	724.3200.400	TOP (UPPER)
11399	LS44SP	0,411 - 0,420	1150 x 888	724.3250.300	BOTTOM (LOWER)
11398 NT	LS44SP	0,35	1150 x 888	724.3200.300	PLAIN STEEL / NT
11401	LT832 IIA	0,411 - 0,420		BA43395200-T5	
11401 NT	LT832 IIA	0,30		BA58873200-T3	

#### IMPORTANT - IMPORTANTE - IMPORTANTE

- The mounting of the Impression Cylinder Jackets must be done by highly-qualified technicians specialized in the maintenance and servicing of printing presses.
- Il montaggio delle Impression Cylinder Jackets deve essere svolto da tecnici specializzati nel mantenimento e nel servizio delle macchine da stampa.
- El montaje del Impression Cylinder Jackets debe hacerse por técnicos especializados en el mantenimiento y servicios técnicos de las máquinas de imprimir.





# IMPRESSION CYLINDER JACKETS FOR HEIDELBERG, KOMORI AND OTHER PRESSES

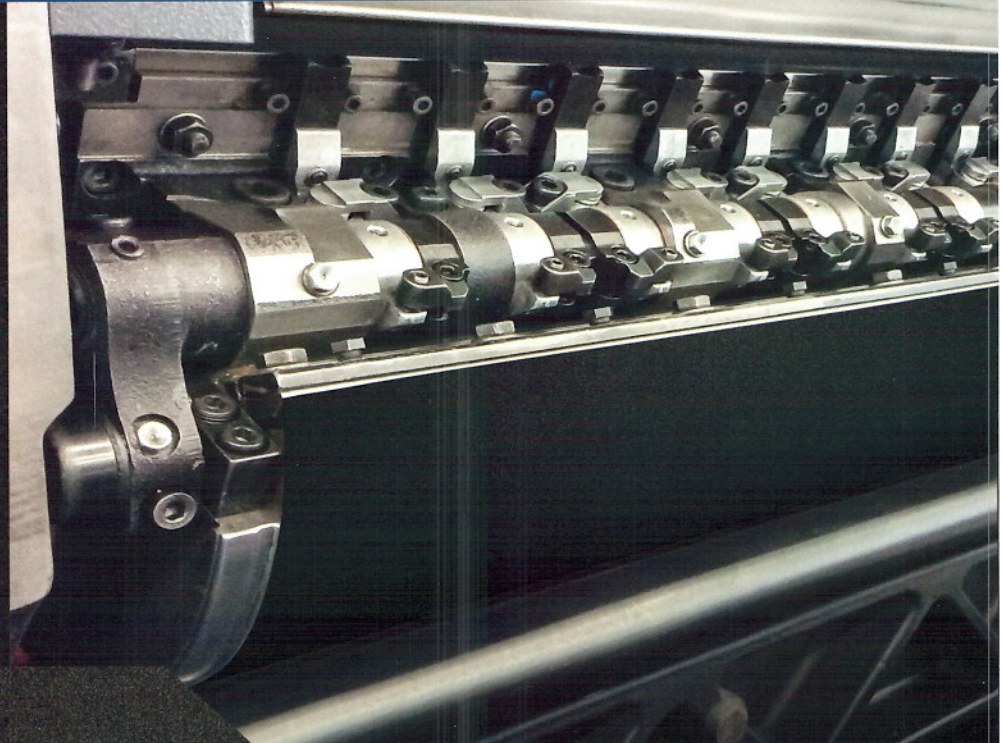

## CERAMIC TREATED jackets

INFINITE QUALITY AND DURABILITY

For more information check our catalogue: *Cylinder Jacket Planet!*

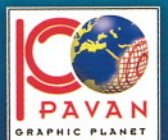
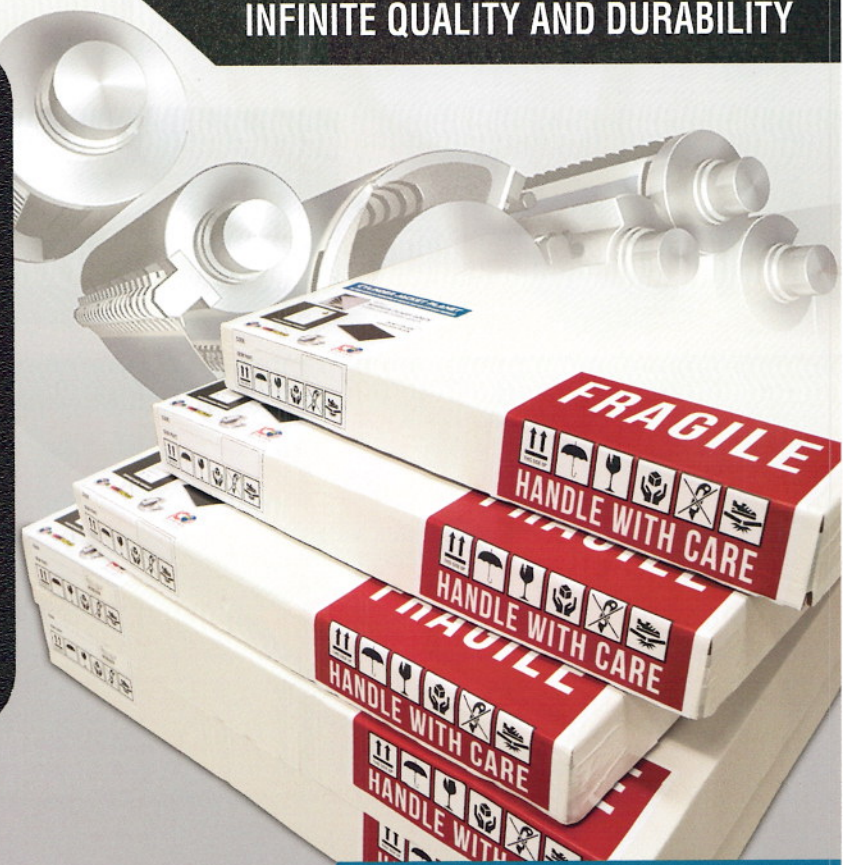
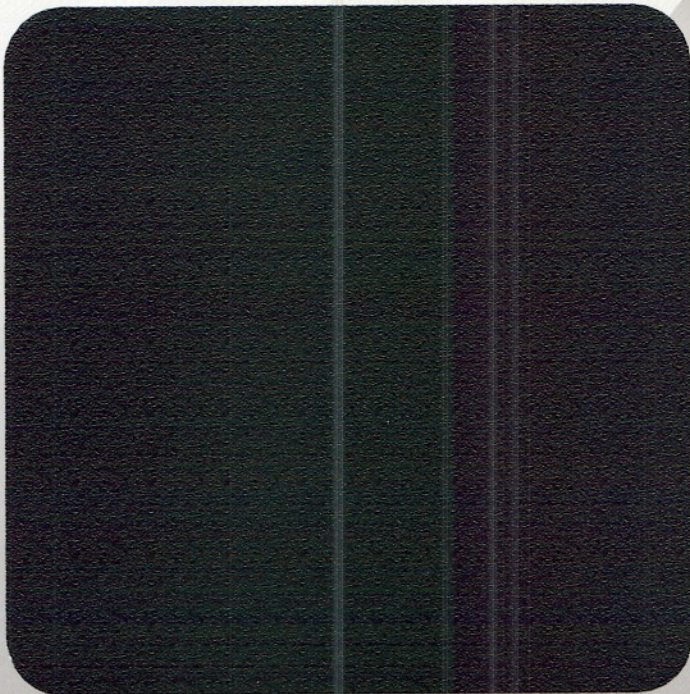

CYLINDER JACKET PLANET



# **SPEED** FILM **BLUE**<sup>®</sup> **STANDARD**

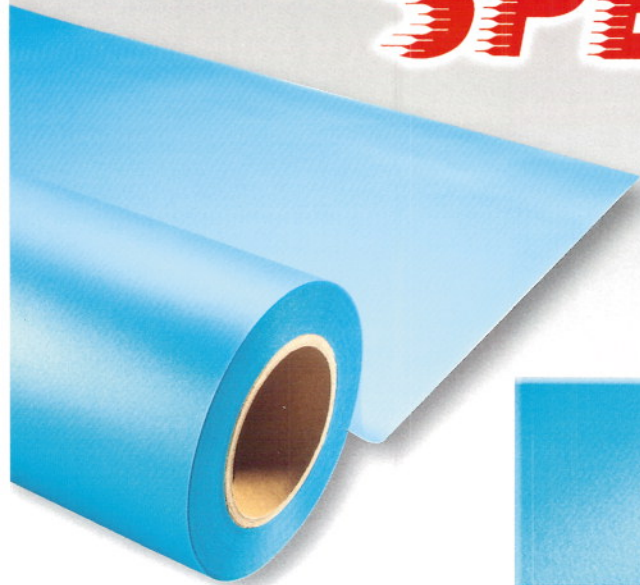

**SPEED FILM BLUE STANDARD**  
può essere fornito  
tagliato in fogli (in qualsiasi misura  
in formato) o in rotoli

**SPEED FILM BLUE STANDARD**  
can be supplied either  
in formatted sheets  
(in any size) or in rolls

**SPEED FILM BLUE STANDARD**  
se puede suministrar  
cortado en formatos  
(de cualquier medida)  
o en rollos

# **SPEED** FILM **BLUE**<sup>®</sup> **PLUS**

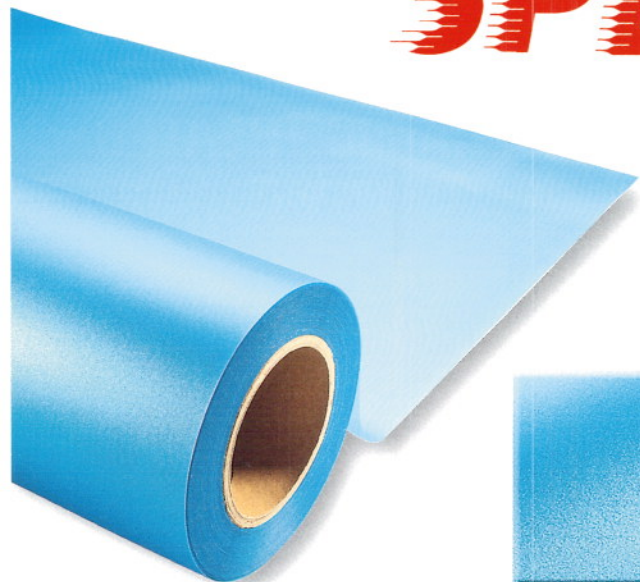

**SPEED FILM BLUE PLUS**  
può essere fornito  
tagliato in fogli (in qualsiasi misura  
in formato) o in rotoli

**SPEED FILM BLUE PLUS**  
can be supplied either  
in formatted sheets  
(in any size) or in rolls

**SPEED FILM BLUE PLUS**  
se puede suministrar  
cortado en formatos  
(de cualquier medida)  
o en rollos

# **SPEED** PAPER<sup>®</sup>



**SPEED PAPER/CARTA**  
può essere fornito  
tagliato in fogli  
(in qualsiasi misura  
in formato) o in rotoli

**SPEED PAPER**  
can be supplied either  
in formatted sheets  
(in any size) or in rolls

**SPEED PAPER/PAPEL**  
se puede suministrar  
cortado en formatos  
(de cualquier medida)  
o en rollos



ADESIVO / ADHESIVE / ADHESIVO

NON ADESIVO / NON-ADHESIVE / NO ADHESIVO

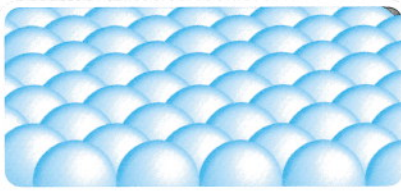

Ingrandimento superficie  
Surface enlargement  
Ampliacion superficie

RUGOSITÀ DELLE SUPERFICIE SURFACE ROUGHNESS RUGOSIDAD DE LA SUPERFICIE	70 my
SPESSORE THICKNESS ESPESOR	0,16 mm

ADESIVO / ADHESIVE / ADHESIVO

NON ADESIVO / NON-ADHESIVE / NO ADHESIVO



Ingrandimento superficie  
Surface enlargement  
Ampliacion superficie

RUGOSITÀ DELLE SUPERFICIE SURFACE ROUGHNESS RUGOSIDAD DE LA SUPERFICIE	170 my
SPESSORE THICKNESS ESPESOR	0,37 mm

ADESIVO / ADHESIVE / ADHESIVO

NON ADESIVO / NON-ADHESIVE / NO ADHESIVO



Ingrandimento superficie  
Surface enlargement  
Ampliacion superficie

RUGOSITÀ DELLE SUPERFICIE SURFACE ROUGHNESS RUGOSIDAD DE LA SUPERFICIE	130 my
SPESSORE THICKNESS ESPESOR	0,27 mm

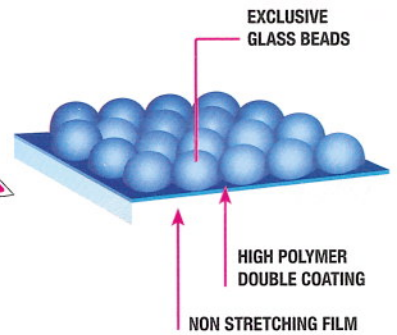
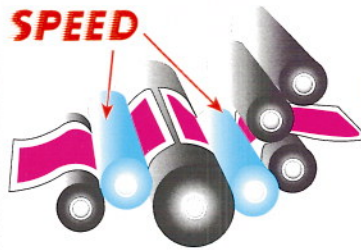

Il primo "esclusivo" prodotto di lavaggio universale specifico per la pulizia di qualsiasi sistema antimacchia con supporto in poliestere  
The first and "unique" universal product specific for the cleaning of any anti-marking system with substrate in polyester  
El primero y "unico" producto universal específico para la limpieza de cualquier sistema antirrepinte con soporte de poliéster

Su richiesta possiamo fornire qualsiasi formato di SPEED FILM e SPEED PAPER completi di biadesivo già applicato ai bordi di ogni foglio  
On specific request we can supply any size of SPEED FILM and SPEED PAPER complete with bi-adhesive strips already attached to the edges of each sheet

Bajo pedido podemos suministrar cualquier formato de SPEED FILM y SPEED PAPER con el biadhesivo ya aplicado en el borde de cada hoja



"SPEED FILM BLUE" è realizzato su un supporto in poliestere. È fornito nella versione "adesiva" e "non adesiva". Il supporto repellente "SPEED FILM BLUE" è stato creato per risolvere e prevenire i problemi di sporco ed accumulo di inchiostro sui cilindri di trasferimento prima che l'inchiostro si asciughi. La risposta a questo problema è "SPEED FILM BLUE" (nella versione adesiva e non). "SPEED FILM BLUE" grazie alla sua eccezionale superficie garantisce una stampa di alta qualità riducendo al minimo lo spreco di carta.



"SPEED FILM BLUE" is made on a polyester substrate. It can be supplied in the "adhesive" or "non-adhesive" version. "SPEED FILM BLUE" has been created to prevent and solve problems with dirt and ink build-up on transfer cylinders. Increasingly higher speeds of offset printing machines mean that printed sheets pass between transfer cylinders before the ink has dried. "SPEED FILM BLUE" (in the adhesive and non adhesive version) is the answer to this problem. "SPEED FILM BLUE", thanks to its exceptional surface, guarantees high quality printing and reduces paper waste to a minimum.



"SPEED FILM BLUE" está realizado sobre un soporte de poliéster. Se suministra en las versiones "Adhesivo" y "No Adhesivo". El soporte repelente "SPEED FILM BLUE" ha sido creado para resolver y prevenir los problemas de suciedad y acumulación de tinta sobre los cilindros de transferencia antes de que la tinta se seque. La respuesta a este problema es el "SPEED FILM BLUE" (en la versión adhesiva o no). "SPEED FILM BLUE" gracias a su excepcional superficie garantiza una impresión de alta calidad reduciendo al mínimo las máculas.



"SPEED PAPER" è realizzato su supporto di carta, ed è realizzato esclusivamente nella versione "non adesiva". Il supporto "SPEED PAPER/CARTA" è stato creato per risolvere e prevenire i problemi di sporco ed accumulo di inchiostro sui cilindri di trasferimento prima che l'inchiostro si asciughi. La risposta a questo problema è "SPEED PAPER/CARTA". "SPEED PAPER/CARTA" grazie alla sua eccezionale superficie, garantisce una stampa di alta qualità riducendo al minimo lo spreco di carta.



"SPEED PAPER" is made on a paper substrate and is only available in the "non-adhesive" version. "SPEED PAPER" has been created to prevent and solve problems with dirt and ink build-up on transfer cylinders. Increasingly higher speeds of offset printing machines mean that printed sheets pass between transfer cylinders before the ink has dried. "SPEED PAPER" is the answer to this problem. "SPEED PAPER" thanks to its exceptional surface, guarantees high quality printing and reduces paper waste to a minimum.



"SPEED PAPER" está realizado sobre un soporte de papel y exclusivamente en la versión "No Adhesivo". El soporte "SPEED PAPER/PAPEL" ha sido creado para resolver y prevenir los problemas de suciedad y acumulación de tinta sobre los cilindros de transferencia antes de que la tinta se seque. La respuesta a este problema es "SPEED PAPER/PAPEL". "SPEED PAPER/PAPEL" gracias a su excepcional superficie garantiza una impresión de alta calidad reduciendo al mínimo las máculas.



# Special Rubber Wash

KOMORI

MEMBRANE LAVACAUCCIU' PER IMPIANTI BALDWIN

RUBBER BLADDERS FOR BALDWIN BLANKET WASHING SYSTEMS

PERFILES DE GOMA PARA SISTEMAS DE LAVADO DE CAUCHOS BALDWIN

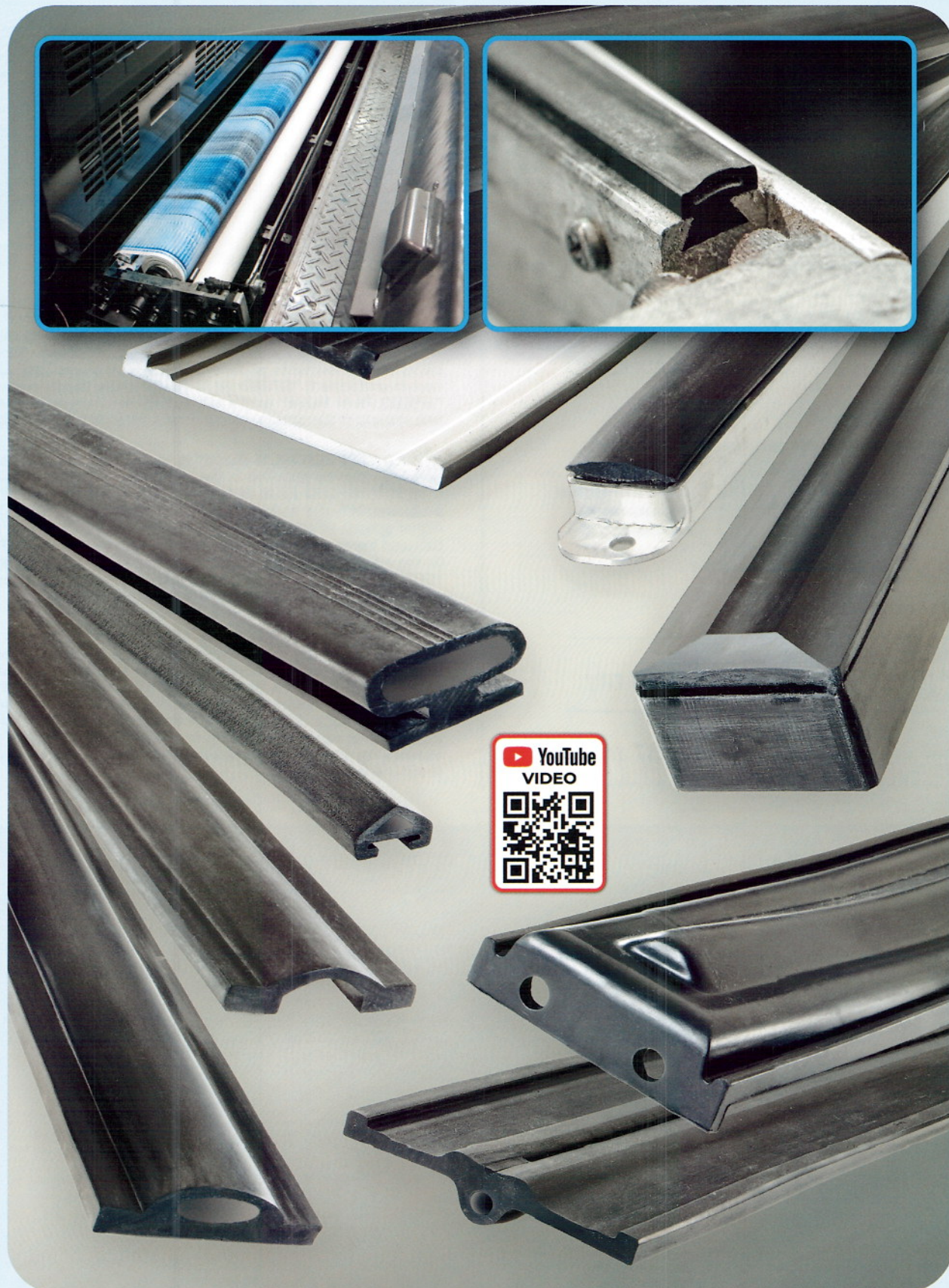



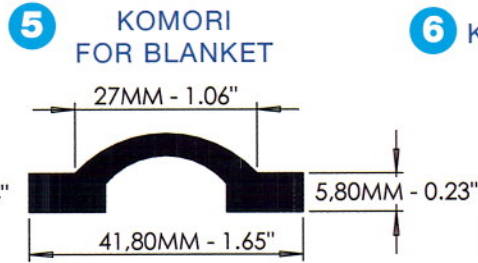
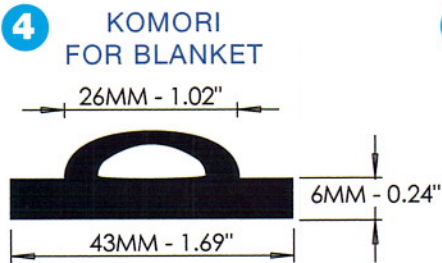
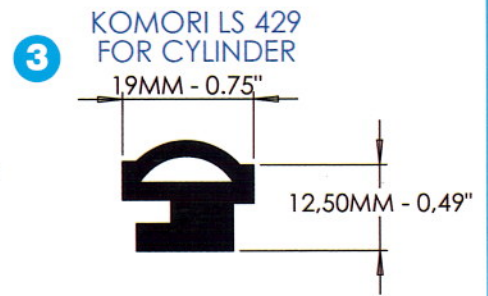
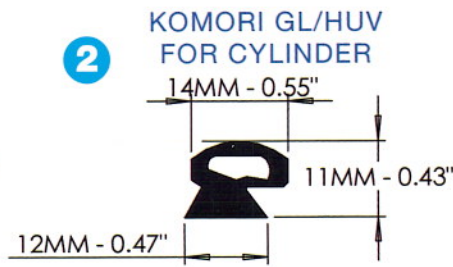
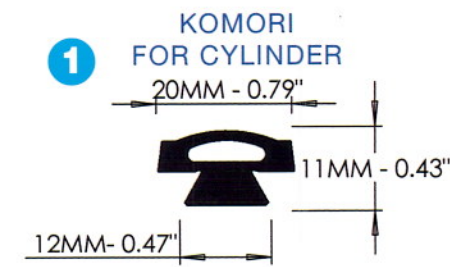

TIPO DI MEMBRANA TYPE OF MEMBRANE TIPO DE PERFILE	CODICE CODE CODIGO	MODELLO MACCHINA MACHINE MODEL MODELO MAQUINA	LUNGHEZZA MM LENGTH MM LONGITUD MM
<b>FOR CYLINDER</b>			
N. 1	27.21460	KOMORI SPRINT 20	540
N. 1	27.21463	KOMORI LITHRONE 26	690
N. 1	27.21465	KOMORI LITHRONE 28	770
N. 1	27.21467	KOMORI LITHRONE 40	1070
N. 1	27.21469	KOMORI LITHRONE 50	1400
N. 2	27.21471	KOMORI GL 40 for H-UV	1080
N. 2	27.21472	KOMORI GL 40 for traditional ink	1080
N. 3	27.21471A	KOMORI LS 429	790
N. 3	27.21471B	KOMORI LS 429 for H-UV	790
N. 3	27.21471C	KOMORI G37	975
N. 3	27.21471D	KOMORI G37 for H-UV	975
<b>FOR BLANKET</b>			
N. 4	27.21474	KOMORI SPRINT 20	540
N. 4	27.21475	KOMORI SPICA 29/429/629	790
N. 4	27.21480	KOMORI LITHRONE 40/540/640/840	1060 or 1090
N. 4	27.21482	KOMORI SPICA 29 for H-UV	790
N. 4	27.21483	KOMORI LITHRONE 40/540/640/840 for H-UV	1060 or 1090
N. 5	27.21483A	KOMORI A37/S37 for traditional ink	970
N. 5	27.21483B	KOMORI A37/S37 for H-UV - LED-UV	970
N. 5	27.21484	KOMORI LS/LSX/GL 40/440/540/640/840 for traditional ink	1060 or 1090
N. 5	27.21485	KOMORI LS/LSX/GL 40/440/540/640/840 for H-UV and LED-UV	1060 or 1090
<b>FOR WEB</b>			
N. 6	27.21476	KOMORI WEB SYSTEM 38	1020





# Il Top Quality nel Mondo

Top Quality Worldwide - El Top Quality en el Mundo

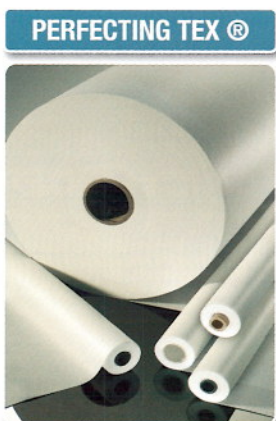
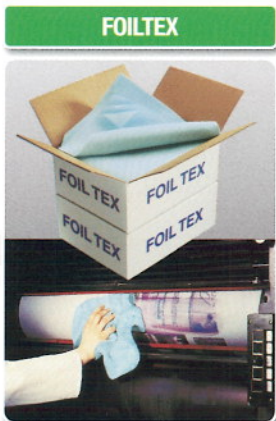

**BOBINE E MINIBOBINE DI TESSUTO  
PER IMPIANTI LAVACAUCIU' E LAVACILINDRO**

**JUMBO AND MINI WASHCLOTH ROLLS  
FOR BLANKET AND CYLINDER WASHING SYSTEMS**

**BOBINAS Y MINI-BOBINAS DE TEJIDO  
PARA INSTALACIONES LAVA-CAUCHOS Y LAVA-CILINDROS**

KOMORI	MM	INCH
KOMORI 20/420/520/620	540	21,26"
KOMORI 26/426	685	26,97"
KOMORI 28/428/528/628/828 STANDARD	745	29,33"
KOMORI SPICA 29 - LSX 29 - ENTHRONE 29	775	30,51"
KOMORI LITHRONE 37	964	37,95"
KOMORI LITHRONE 40 - S 40 - G 40	1054	41,50"
KOMORI LITHRONE SX 40 - GX 40	1074	42,28"
KOMORI LITHRONE 44 SP	1154	45,43"
KOMORI LITHRONE S 44	1174	46,22"
KOMORI LITHRONE 50	1340	52,76"
KOMORI - WEB OFFSET	MM	INCH
KOMORI S 32	840	33,07"
KOMORI S 38	974	38,35"
KOMORI 38/LR 435/538	985	38,78"
KOMORI S 38	998	39,29"
KOMORI S 38	1000	39,37"
KOMORI LR 540 A	1010	39,76"
KOMORI D 38	1020	40,16"
KOMORI CHAMBON 16	1030	40,55"





**THE REASONS BEHIND OUR WORLDWIDE SUCCESS!!**

# **BLU-TEX® WHITE-TEX®**

## **BLU-TEX® MARINE**



**Disponibilità immediata di qualsiasi altezza e quantità =  
Consegna rapidissima = CLIENTE SODDISFATTO!!!**

**Immediate availability of any roll width and any quantity =  
Very rapid delivery = SATISFIED CLIENT!!!**

**Disponibilidad inmediata de cualquier ancho de rollo y cualquier cantidad =  
Entrega muy rapida = CLIENTE SATISFECHO!!!**





***THE REASONS BEHIND OUR WORLDWIDE SUCCESS!!***

# **BLU-TEX® WHITE-TEX®**

# **BLU-TEX® MARINE**



**OUR CLOTHS**

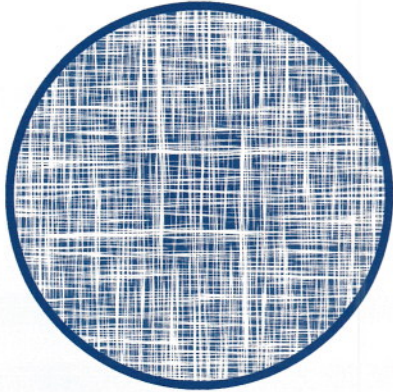

**INTERLACED FIBRE**



**MECHANICAL RESISTANCE**

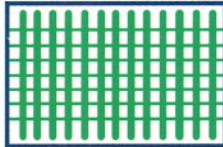

**HOLDS THE SOLVENT MORE UNIFORMLY AND WASHES WITH FEWER CONTACTS. YOU SAVE CONSUMPTION OF CLOTH AND TIME.**

**TOP QUALITY PRODUCT**

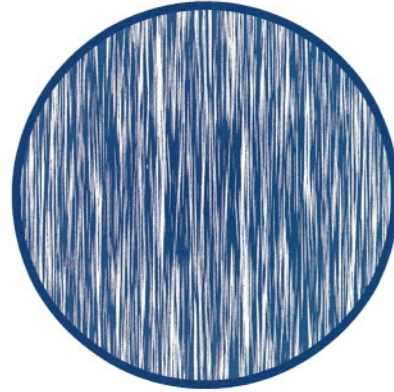

**PARALLEL FIBRE**



**MECHANICAL RESISTANCE**

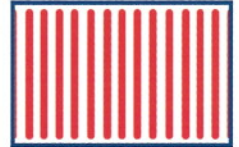

**DOES NOT HOLD THE SOLVENT WELL AND WASHES WITH MORE CONTACTS CONSUMING MORE CLOTH AND MORE TIME.**

**LOW QUALITY PRODUCT**

**AND YOU.. IF THEY HAD THE SAME PRICE WHICH ONE WOULD YOU CHOOSE??**



**WE HAVE THE ONLY WASHCLOTHS FOR PRINTERS WITH AN INTERLACED FIBRE!!**



**NEW  
PRODUCT**  
The Number  
One



# SPIDER TEX

**UNIVERSAL MICRO-PERFORATED WASHCLOTH!**

*\*for sheetfed offset and web offset presses*



## SPECIAL CLOTH

WITH EXCELLENT CLEANING CAPACITY  
FOR BOTH **PRINTING BLANKETS**  
AND **PERFECTING CYLINDERS**.

- ABRASION RESISTANCE	●●●●○
- RAPID ABSORPTION	●●●●○
- INK REMOVAL	●●●●●
- PAPER DUST REMOVAL	●●●●●
- LINTING	●●●●○

JUMBO ROLLS OF 350 LINEAR METRES OR MINI-ROLLS  
AVAILABLE IN ANY WIDTH!



[www.pavanvr.com](http://www.pavanvr.com)



# PERFECTING TEX®

TESSUTO SPECIALE PER IL LAVAGGIO AUTOMATICO DELLE CAMICIE TRATTATE  
 PER I CILINDRI DI PRESSIONE DELLE MACCHINE BIANCA E VOLTA  
 SPECIAL WASHCLOTH FOR AUTOMATIC WASHING OF TREATED IMPRESSION CYLINDER JACKETS  
 IN THE PERFECTING UNITS OF THE PRESS  
 TEJIDO ESPECIAL PARA EL LAVADO AUTOMATICO DE LAS CAMISAS TRATADAS DE LOS CILINDROS  
 DE PRESION PARA MAQUINAS DE TIRO Y RETIRO

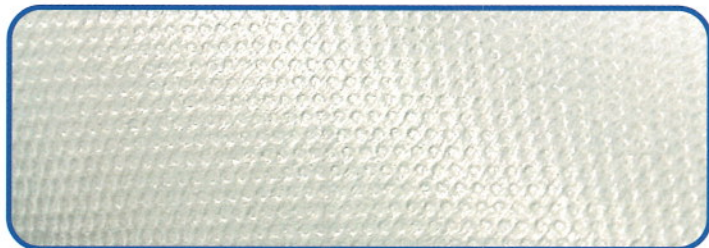
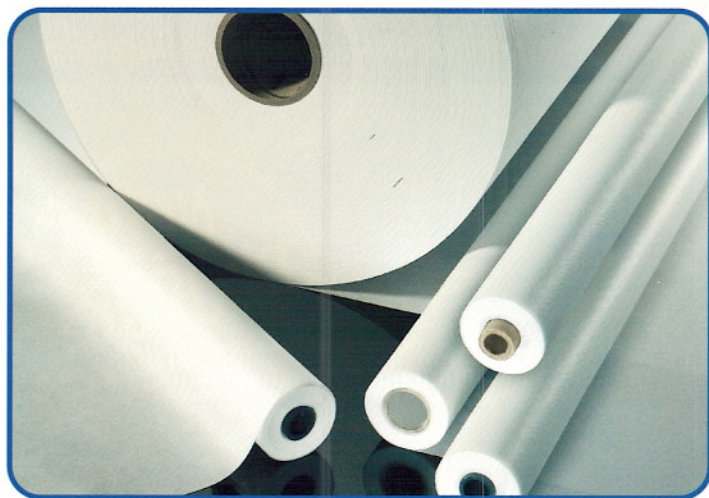

La speciale superficie "in rilievo" di "PERFECTING TEX" rimuove più facilmente i residui di inchiostro e di polvere di carta presente sulla superficie della camicia. "PERFECTING TEX" è molto resistente all'abrasione, non si sfibra e non lascia residui.



The special surface "relief" surface of the "PERFECTING TEX" removes ink residues and paper dust more easily from the surface of the jacket. "PERFECTING TEX" has a high scratch resistance, it does not fray or leave residue.



La superficie especial "en relieve" del "PERFECTING TEX", recoge con facilidad los residuos de tinta y del polvo del papel que se encuentran en la superficie de la camisa. "PERFECTING TEX" es muy resistente a la abrasión, no se deshila y no deja residuos.

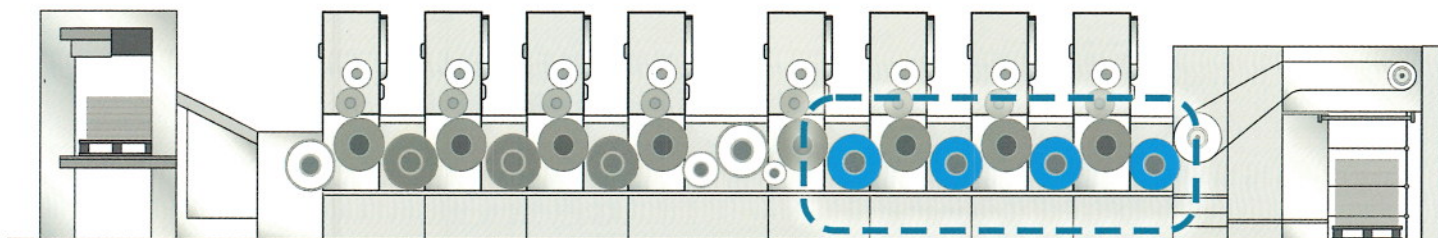

**ONLY FOR PERFECTING UNITS**

## KOMORI

### PERFECTING TEX® MINI (MINI ROLLS)

CODICE CODE CODIGO	MODELLO MACCHINA MACHINE MODEL MODELO MAQUINA	ALTEZZA MM WIDTH MM ANCHO MM	LUNGHEZZA MT LENGTH M. LONGITUD M.	ROTOLI PER SCATOLA ROLLS PER BOX ROLLOS POR CAJA
16025	KOMORI LITHRONE 28	745	5	40
16026	KOMORI SPICA 29 - LSX 29	775	5	30
16035	KOMORI LITHRONE 40	1054	8	24
16035B	KOMORI LITHRONE 40 SPECIAL	1054	10	24
16035C	KOMORI LITHRONE 40 SPECIAL	1054	13	15
16036	KOMORI LITHRONE SX 40 - GX 40	1070	8	24
16037	KOMORI LITHRONE 44	1154	11	24
16035A	KOMORI LITHRONE 44	1170	8	30

### PERFECTING TEX® MAXI (JUMBO ROLLS)

16100	KOMORI LITHRONE 28	745	500	1
16105	KOMORI SPICA 29 - LSX 29	775	500	1
16110	KOMORI LITHRONE 40/440/540/640/840	1050	500	1
16090	KOMORI LITHRONE SX 40 - GX 40	1070	500	1
16120	KOMORI LITHRONE 44	1170	500	1



# PRE-TEX®

CMIS  
PATENTED PRODUCTION  
SYSTEM TECHNOLOGY

Mini rotolini pre-impregnati per sistemi di pulizia automatici  
*Pre-impregnated mini-rolls for automatic washing systems*  
*Mini rollos pre-impregnados para sistemas automáticos de limpieza*

**KOMORI**

FOR SHEETFEED OFFSET  
AND WEB OFFSET PRESSES  
FOR TRADITIONAL INKS,  
UV AND H-UV INKS

THE ONLY "CUSTOMIZED"  
PRE-IMPREGNATED ROLLS...  
IN THE WORLD!



**CERTIFIED BY**



TEST CERTIFICATE NUMBER: 26921

**CMIS technology®**

Sistema di Impregnazione Micrometrica Controllata  
(PROCESSO DI PRODUZIONE BREVETTATO)

Controlled Micrometric Impregnation System  
PATENTED

Sistema de Impregnación Micrométrica Controlada







# PRE-TEX®

Pre-impregnated mini-rolls for automatic washing systems

**MAXIMUM RESULTS - MINIMUM WASTE - MAXIMUM SAVING**

## 10 reasons why PRE-TEX® is UNIQUE

- All Pre-TEX® solvents are **ISEGA certified**
- **Ready for use:** no preparation is needed
- Uniform impregnation, **NOT soaked to saturation** (immersion)
- Re-start-up with **minimal waste**, every other system creates a lot more
- Micrometric impregnation, no wash on the plate, **no fogging**
- Optimization of washing programmes **without wasting cloth**
- **No loss** of wash on the grippers and moving parts of the press
- Every wash guaranteed to be **perfect in all the printing units**
- **Wash times** drastically reduced by half, also in the large size presses
- Vacuum sealed, safe storage, **unlimited shelf life**



The most complete programme of pre-impregnated washcloth rolls on the market, suitable for all **Offset and Web-Offset machines**, available in all sizes and for use with all kinds of inks: **TRADITIONAL, UV, HUV, HYBRID, COLDSET and HEATSET.**

The technical production procedure guarantees a **perfectly uniform and stable micrometric impregnation** on the complete surface of the washcloth roll. It guarantees a level of washing of incomparable quality, thanks to the perfect and **gradual release of the wash solvent.**

### Pre-TEX® is unbeatable !



With a simple test you will have clear evidence of a considerable saving of time and a surprising number of washes !



Moreover, by eliminating the internal washing system, you will have a significant reduction of maintenance of the components subject to wear and tear !



The **high quality Pre-TEX® washes**, which guarantee a very good cleaning of the inks, were **studied for impregnation**, with parameters regarding the density, stability and tension-activity which are different to the normal washes used for standard wash procedures.

### Possibility of converting the washing systems in use.

All the **Offset and Web-Offset machines** equipped with washing systems for blankets and impression cylinders, that use dry washcloth rolls, **are convertible to the Pre-TEX® system.**

**NUM PACK Patented - AETERNUM PACK Patented - AETERNUM PACK Patented - AETERNUM**



# PRE-TEX® FOR WEB-OFFSET

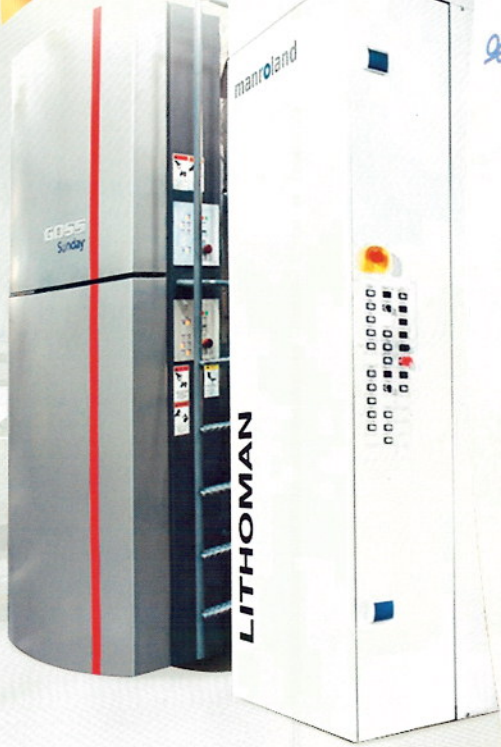

KBA



*"Pavan Forniture Grafiche S.p.A thanks all their clients who over these 10 years have chosen PRE-TEX WEB for their Goss - Heidelberg - Manroland - KBA Wifag - Komori - Mitsubishi - Timson presses."*

**10 Years of PRE-TEX® WEB-OFFSET**  
**10 Years of sales worldwide**  
**10 Years of technological innovation**  
**10 Years of QUALITY.**

Luca Pavan



JM PACK Patented - AETERNUM PACK Patented - AETERNUM PACK Patented - AETER





# CONVERSION KIT KOMORI L40

PER SOSTITUIRE LE MEMBRANE DI LAVAGGIO DELLE VECCHIE KOMORI L40

TO REPLACE THE WASHING BLADDERS IN THE OLD KOMORI L40 PRESSES

PARA SUSTITUIR LOS PERFILES DE LAVADO DE LAS ANTIGUAS MAQUINAS KOMORI L40

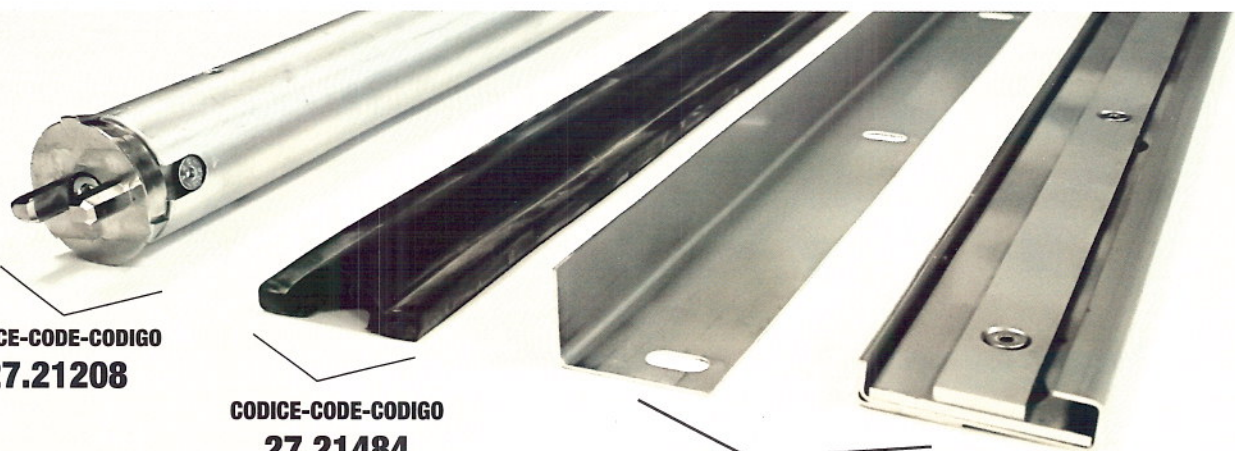
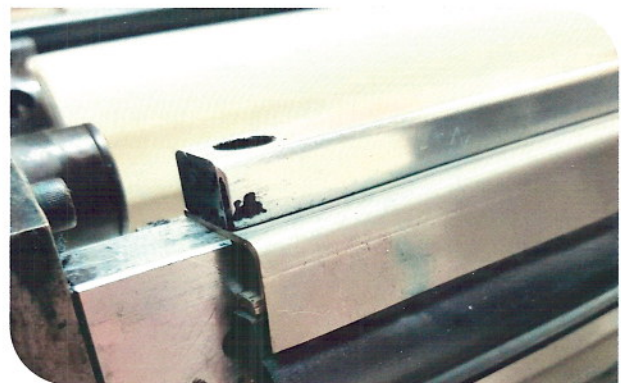
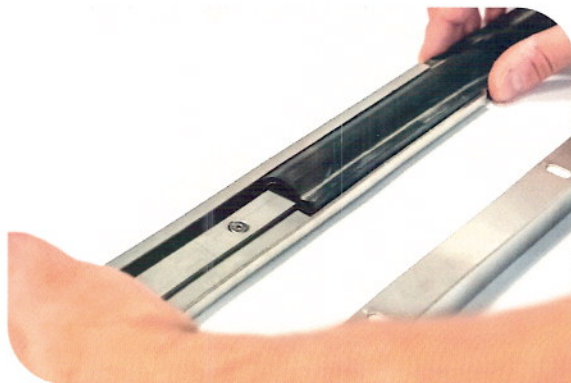
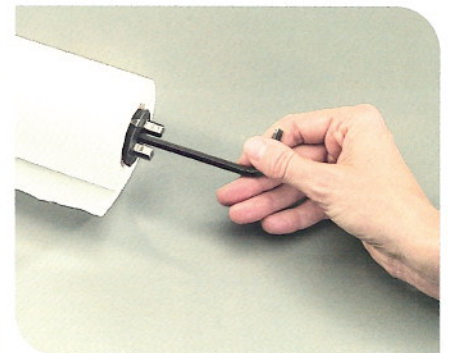
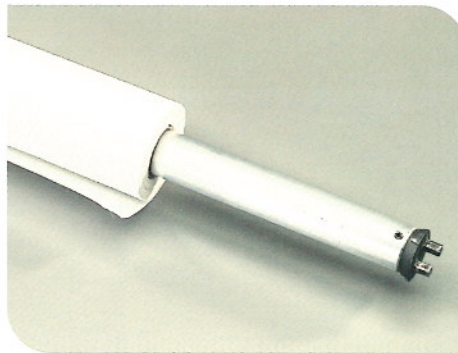
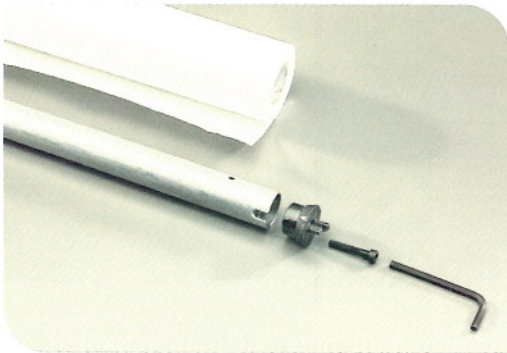

CODICE-CODE-CODIGO  
**27.21208**

CODICE-CODE-CODIGO  
**27.21484**  
**27.21485**

CODICE-CODE-CODIGO  
**27.21207**

LA "SPECIAL RUBBER WASH" HA UN RUOLO PRINCIPALE DURANTE IL LAVAGGIO DEI CAUCCIU'.  
LA MEMBRANA IN GOMMA PERMETTE UN LAVAGGIO PIÙ OMOGENEO ED EFFICACE.  
**CONSIGLIAMO IL KIT DI CONVERSIONE PER IL PASSAGGIO DA TESSUTO ASCIUTTO A PRE-TEX.**

"SPECIAL RUBBER WASH" IS FUNDAMENTAL DURING THE BLANKET WASHING PROCESS.  
THE RUBBER BLADDER ALLOWS FOR A MORE UNIFORM AND EFFICIENT WASH.  
**WE ADVISE THE CONVERSION KIT TO CHANGE FROM DRY WASHCLOTH TO PRE-TEX.**

EL "SPECIAL RUBBER WASH" TIENE UN PAPEL PRINCIPAL AL LAVADO DE CAUCHO.  
EL PERFIL DE GOMA PERMITE UN LAVADO MÁS HOMOGÉNEO Y EFECTIVO.  
**RECOMENDAMOS EL KIT DE CONVERSIÓN PARA LA TRANSICIÓN DE TEJIDO SECO A PRE-TEX.**



# PRE-TEX<sup>®</sup> ECO SUSTAINABILITY

The technology of the printing press manufacturers has been following the progressive use of pre-impregnated washcloth rolls for many years. Today this technology is widely applied all over the world. We should not exclude the possibility that, in the near future, the continuous restrictions of the environmental regulations linked to the ecological impact in the working environment, will lead to the total elimination of the use of dispersion wash solvents in the printroom.



Pavan Forniture Grafiche S.p.A  
has created the first **conversion service** in the world  
market to **eliminate the dispersion of solvents**  
in the working environment and to **reduce**  
the consumption of washcloth by **40%**  
***on all KOMORI press models.***



Advantages in terms of:  
**TIME, SOLVENT, CLOTH**

## LESS WATER

Much less water used in the press.



## LESS CLOTH

Lower cloth consumption for the same number of washes. Less washcloth to dispose of after use.



## LESS SOLVENT

No dispersion solvents in the printroom.  
Solvent is contained exclusively in the Pre-tex rolls.



## LESS POLLUTION !



**Pre-TEX<sup>®</sup> supports the environment !**  
As well as gaining more printing time,  
you will have a lower consumption of water in the  
press, a lower consumption of washcloth and  
a reduced dispersion of solvent.





High performance offset blanket for Sheet-fed & Web-offset  
**PRINTING Blankets**

# SUMITOMO

## The new generation

high quality compressible printing Blankets for any type of printing

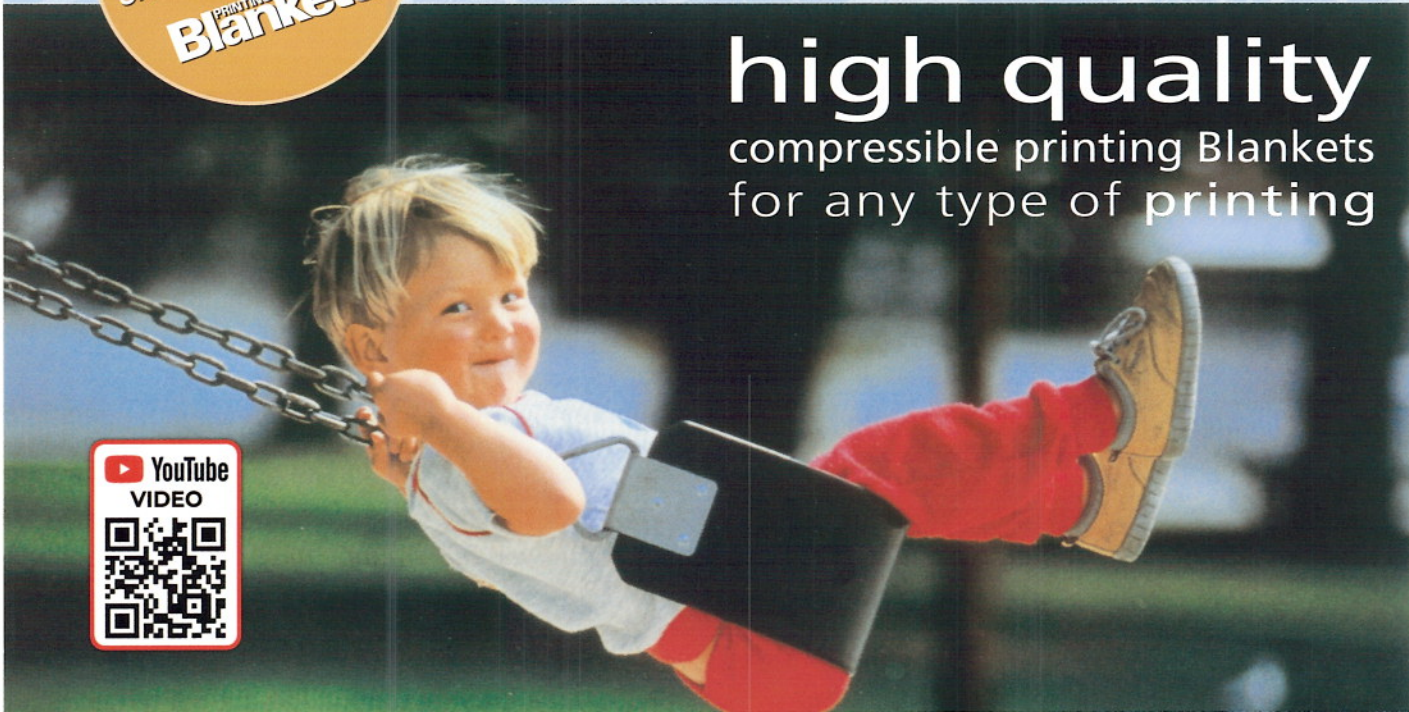

SUMITOMO OFFSET PRINTING BLANKET

	COLOUR	BLUE	CONSTRUCTION	3FABRIC LAYERS
	ROUGHNESS RA	0,7 µM	HARDNESS (TOTAL)	79° SHORE A
	APPLICATION FIELDS	SHEETFED, METAL DECORATING, PACKAGING.	INK COMPATIBILITY	CONVENTIONAL AND HYBRID INKS.
	THICKNESS MM	1,70/1,95 ± 0,02 MM	COMPRESSIBILITY	28-42 KG/CM <sup>2</sup> A 0,32 MM DEFORMATION

### S-PRIA BLUE



	COLOUR	DARK BLUE	CONSTRUCTION	3FABRIC LAYERS
	ROUGHNESS RA	0,9 µM	HARDNESS (TOTAL)	79° SHORE A
	APPLICATION FIELDS	SHEETFED, METAL DECORATING, PACKAGING.	INK COMPATIBILITY	CONVENTIONAL AND U.V. INKS.
	THICKNESS MM	1,95 ± 0,02 MM	COMPRESSIBILITY	28-42 KG/CM <sup>2</sup> A 0,32 MM DEFORMATION

### S-PRIA BLUE PLUS



	COLOUR	GREEN	CONSTRUCTION	4FABRIC LAYERS
	ROUGHNESS RA	0,7 µM	HARDNESS (TOTAL)	80° SHORE A
	APPLICATION FIELDS	SHEETFED, COMMERCIAL WEB, PACKAGING	INK COMPATIBILITY	CONVENTIONAL AND U.V. INKS.
	THICKNESS MM	1,95 ± 0,02 MM	COMPRESSIBILITY	23-38 KG/CM <sup>2</sup> A 0,22 MM DEFORMATION

### S-PRIA EMERALD



	COLOUR	VIOLET	CONSTRUCTION	3FABRIC LAYERS
	ROUGHNESS RA	0,7 µM	HARDNESS (TOTAL)	79° SHORE A
	APPLICATION FIELDS	SHEETFED, METAL DECORATING, PACKAGING.	INK COMPATIBILITY	UV FOR "H-UV" - "LE-UV" - "LEC-UV" - "HR-UV"
	THICKNESS MM	1,95 ± 0,02 MM	COMPRESSIBILITY	28-42 KG/CM <sup>2</sup> A 0,32 MM DEFORMATION

### SB14





# ROYAL DOT

**AL VERTICE DELLA QUALITÀ  
THE SUMMIT OF QUALITY  
EN LA CUMBRE DE LA CALIDAD**



**THE BEST QUALITY FOR  
KOMORI MACHINES**



UNIQUE PRODUCTION TECHNOLOGY

*If you mount them correctly ..... you will love them !!!*

**N.T.L.T.®**  
No Thickness Loss technology

**ROYAL DOT DYNAMIC BLANKETS**  
THE BEST QUALITY PROGRAMME OF COMPRESSIBLE PRINTING BLANKETS

**THE ONLY PRINTING BLANKETS THAT DO NOT LOSE "THICKNESS" !!!**

**CORRECT PACK**  
Correct packing as indicated in the technical manual

**INCORRECT PACK**  
Incorrect packing as shown

**RULE FOR THE OPTIMAL MOUNTING OF PRINTING BLANKETS**  
The innovative production technology of this product requires that you respect the thickness of the total pack (blanket + underpacking), as indicated in the "Technical Manual".

**DO NOT ADD +0.5mm!**  
If you respect this condition, you are guaranteed the maximum quality performance and durability of the product.

**ISEGA APPROVED** for food, toy and medical industry



**30 Anni di esperienza  
e di continui successi!!**

L'esperienza maturata ed acquisita in tutti questi anni nella commercializzazione dei tessuti gommati, ci ha permesso di selezionare un'esclusiva gamma di prodotti specifici risultanti essere i migliori nel loro impiego. Abbiamo scelto il meglio che il mercato mondiale oggi propone!! La gamma di tessuti gommati **"ROYAL DOT DYNAMIC"** è interamente certificata sotto il marchio di garanzia **"ROYAL DOT DYNAMIC"**. Su richiesta l'intera gamma di tessuti gommati **"ROYAL DOT DYNAMIC"** può essere fornita con una vostra etichetta privata personalizzata. Contattateci per avere maggiori informazioni in merito.



**30 Years of experience  
and continuous success!!**

The experience we have gathered and acquired in all these years of selling printing blankets has allowed us to select an exclusive range of products whose performance is at the top of the scale. We have chosen the best that today's market offers!! The **"ROYAL DOT DYNAMIC"** range of printing blankets is entirely certified under the guaranteed trademark **"ROYAL DOT DYNAMIC"**. On request, the complete range of **"ROYAL DOT DYNAMIC"** printing blankets can be supplied with your own private personalized label. Contact us for further details.



**¡¡30 Años de experiencia  
de continuos exitos!!**

La experiencia madurada y conseguida en todos estos años, en la comercialización de cauchos, nos ha permitido el seleccionar una gama exclusiva de productos específicos resultando ser los mejores. ¡¡Hemos escogido lo mejor que hoy propone el mercado mundial!! La gama de cauchos **"ROYAL DOT DYNAMIC"** está certificada completamente bajo la marca de garantía **"ROYAL DOT DYNAMIC"**. Bajo pedido, la gama completa de cauchos **"ROYAL DOT DYNAMIC"** se puede suministrar con su etiqueta privada personalizada. Contáctenos para tener mayor información al respecto.



**ROYAL DOT**  
"5500" DYNAMIC

COLOUR	LIGHT BLUE	CONSTRUCTION	3 FABRIC LAYERS
ROUGHNESS RA	0,8 ÷ 1,00 µM	HARDNESS (TOTAL)	77° SHORE A
APPLICATION	SHEETFED, METAL DECORATING, PACKAGING.	INK COMPATIBILITY	CONVENTIONAL AND UV INKS
THICKNESS MM	1,95 ± 0,02 MM	COMPRESSIBILITY	20-35 KG/CM <sup>2</sup> A 0,23 MM DEFORMATION



**ROYAL DOT**  
"6000" DYNAMIC

COLOUR	BLUE	CONSTRUCTION	3 FABRIC LAYERS
ROUGHNESS RA	0,8 ÷ 1,00 µM	HARDNESS (TOTAL)	77° SHORE A
APPLICATION	SHEETFED, HEATSET, COLDSET	INK COMPATIBILITY	CONVENTIONAL AND UV INKS
THICKNESS MM	1,70/1,95 ± 0,02 MM	COMPRESSIBILITY	20-35 KG/CM <sup>2</sup> A 0,23 MM DEFORMATION



**ROYAL DOT**  
MASTER

COLOUR	DARK BLUE	CONSTRUCTION	3 FABRIC LAYERS
ROUGHNESS RA	0,8 ÷ 1,00 µM	HARDNESS (TOTAL)	77° SHORE A
APPLICATION FIELDS	SHEETFED, PACKAGING	INK COMPATIBILITY	CONVENTIONAL AND HYBRID INKS.
THICKNESS MM	1,70/1,95 ± 0,02 MM	COMPRESSIBILITY	20-35 KG/CM <sup>2</sup> A 0,23 MM DEFORMATION



**ROYAL DOT**  
"DUAL" DYNAMIC

COLOUR	GREY	CONSTRUCTION	3 FABRIC LAYERS
ROUGHNESS RA	0,8 ÷ 1,00 µM	HARDNESS (TOTAL)	77° SHORE A
APPLICATION	SHEETFED, COMMERCIAL WEB, PACKAGING	INK COMPATIBILITY	CONVENTIONAL AND UV INKS
THICKNESS MM	1,95 ± 0,02 MM	COMPRESSIBILITY	20-35 KG/CM <sup>2</sup> A 0,23 MM DEFORMATION

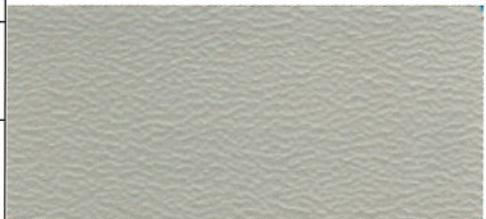

**ROYAL DOT**  
"8000" DYNAMIC UV METAL  
"8000" DYNAMIC UV

COLOUR	VIOLET	PURPLE	CONSTRUCTION	3 FABRIC LAYERS
ROUGHNESS RA	ACCORDING TO APPLICATION		HARDNESS (TOTAL)	60° SHORE A / 77° SHORE A
APPLICATION FIELDS	SHEETFED, METAL DECORATING, PACKAGING.		INK COMPATIBILITY	UV FOR "H-UV"- "LE-UV"- "LEC-UV"- "HR-UV"
THICKNESS MM	1,95 ± 0,02 MM	1,70/1,95 ± 0,02 MM	COMPRESSIBILITY	16-26 KG/CM <sup>2</sup> / 20-35 KG/CM <sup>2</sup> A 0,23 MM DEFORMATION

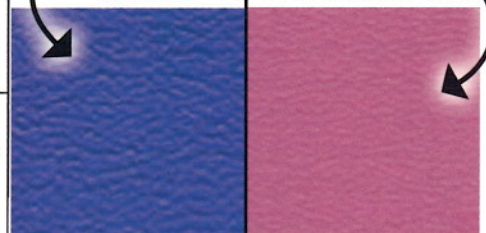



	COLOUR	BLACK	CONSTRUCTION	3 FABRIC LAYERS
	ROUGHNESS RA	ACCORDING TO APPLICATION	HARDNESS (TOTAL)	77° SHORE A
	APPLICATION FIELDS	SHEETFED, METAL DECORATING, PACKAGING.	INK COMPATIBILITY	UV FOR "H-UV"- "LE-UV"- <b>"LEC-UV"</b> – "HR-UV"
	THICKNESS MM	1,70/1,95 ± 0,02 MM	COMPRESSIBILITY	20-35 KG/CM <sup>2</sup> A 0,23 MM DEFORMATION

## ROYAL DOT BLACK UV

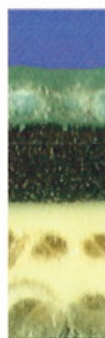

	COLOUR	VIOLET	CONSTRUCTION	3 FABRIC LAYERS
	ROUGHNESS RA	ACCORDING TO APPLICATION	HARDNESS (TOTAL)	77° SHORE A
	APPLICATION FIELDS	SHEETFED, COMMERCIAL WEB, PACKAGING	INK COMPATIBILITY	UV FOR "H-UV"- "LE-UV"- <b>"LEC-UV"</b> – "HR-UV"
	THICKNESS MM	1,95 ± 0,02 MM	COMPRESSIBILITY	20-35 KG/CM <sup>2</sup> A 0,23 MM DEFORMATION

## ROYAL DOT UV PLUS

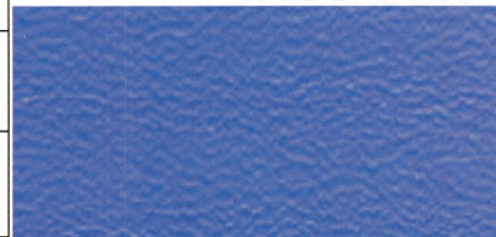

	COLOUR	BLACK	CONSTRUCTION	3 FABRIC LAYERS
	ROUGHNESS RA	0,4 ÷ 0,6 µM	HARDNESS (TOTAL)	80° SHORE A
	APPLICATION FIELDS	PLASTIC POT, TUBES	INK COMPATIBILITY	RESISTANT TO UV INKS
	THICKNESS MM	1,70/1,95 ± 0,02 MM	COMPRESSIBILITY	75 KG/CM <sup>2</sup> DEFORMATION

## ROYAL DOT PLAST UV



	COLOUR	DARK BLUE	CONSTRUCTION	3 FABRIC LAYERS
	ROUGHNESS RA	0,8 ÷ 1,00 µM	HARDNESS (TOTAL)	77° SHORE A
	APPLICATION FIELDS	WEB OFFSET	INK COMPATIBILITY	CONVENTIONAL AND HYBRID INKS
	THICKNESS MM	1,70/1,95 ± 0,02 MM	COMPRESSIBILITY	20-35 KG/CM <sup>2</sup> A 0,23 MM DEFORMATION

## ROYAL DOT WEB

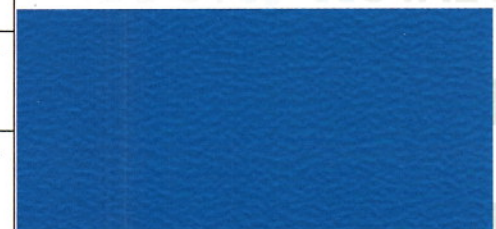

	COLOUR	DARK GREY	CONSTRUCTION	2 FABRIC LAYERS
	ROUGHNESS RA	0,5 ÷ 0,7 µM	HARDNESS (TOTAL)	60° SHORE A
	APPLICATION FIELDS	SPECIFIC FOR CORRUGATED BOARD	INK COMPATIBILITY	RESISTANT TO CONVENTIONAL
	THICKNESS MM	2,07 +/- 0,02 MM	COMPRESSIBILITY	18-32 KG/CM <sup>2</sup> A 0,21 MM DEFORMATION

## ROYAL DOT -KARTON-





# NEW SERVICE P&C ( PARKING & CUTTING )

QUALITY, SPEED, ECONOMY



NOW YOU CAN PURCHASE OUR VAST RANGE OF PRINTING BLANKETS



**SUMITOMO**  
RUBBER INDUSTRIES



&

**ROYAL DOT**



AT A PURCHASE PRICE (RESERVED FOR BLANKET ROLLS)  
AS IF YOU HAD IN YOUR COMPANY A CONVERTING SYSTEM  
(PARKING & CUTTING + BARRING)!

4 AUTOMATIC CUTTING SYSTEMS - 4 MANUAL CUTTING SYSTEMS  
3 BARRING STATIONS



**NEW** PARKING AND CUTTING SERVICE:  
**ALL INCLUDED IN THE PRICE !!!**



1) PARKING



2) CUTTING



3) BARRING



4) STAMPING



5) PACKAGING



## 1) PARKING

Blanket rolls remain in our stock, ready to be cut to order.



## 2) CUTTING

Printing blankets are cut to size from jumbo rolls using our automatic cutting systems.

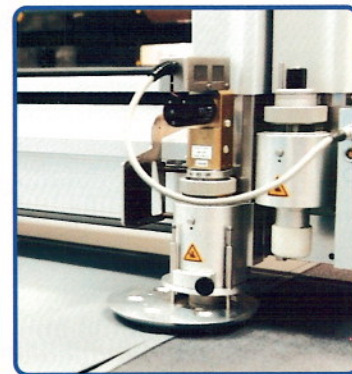

## 3) BARRING

After the conversion, blankets are barred using our 4 presses (each press has a maximum width of 2200 mm).



## 4) STAMPING

Each blanket is marked on the back with the blanket brand name and the dealer's contact details. Our company name will never appear.

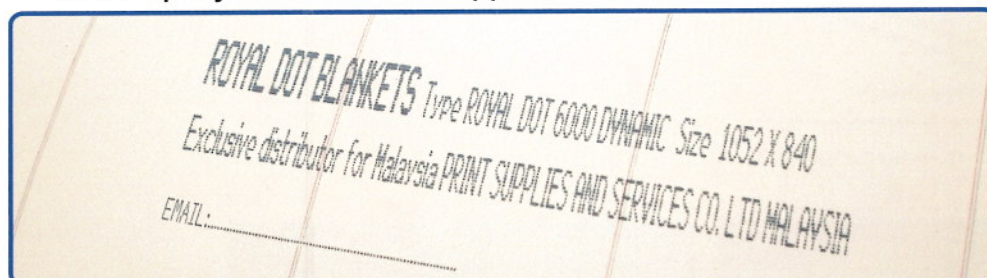

## 5) PACKAGING

On the basis of the size and quantity of blankets, we pack them in rolls, ready for dispatch (in multiples of 4/5/6 pcs).



FOR MORE INFORMATION, SEND YOUR REQUEST BY E-MAIL TO:

[veronica@pavanvr.com](mailto:veronica@pavanvr.com) - [susan@pavanvr.com](mailto:susan@pavanvr.com)

copyright © Pavan Forniture Grafiche S.p.A - [www.pavanvr.com](http://www.pavanvr.com) - [pavan@pavanvr.com](mailto:pavan@pavanvr.com)



# QUICK CUT AND QUICK BAR SERVICE

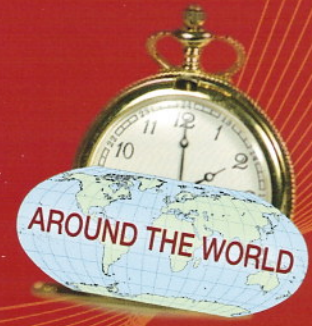

QUALITÀ, RAPIDITÀ, CONVENIENZA - QUALITY, SPEED, ECONOMY - CALIDAD, RAPIDEZ, CONVENIENCIA



**KOMORI 40 UNIVERSAL**

BARRA IN ALLUMINIO  
ALUMINIUM BAR  
BARRA EN ALUMINIO

BARRA-BAR-BARRA  
38121-SAB-15

**KOMORI SPRINT 25/26/28/ SYSTEM 20/20 A**  
**KOMORI LITHRONE 25/26/28/40/50**  
nuovo modello - new model - nuevo modelo

BARRA IN ALLUMINIO  
ALUMINIUM BAR  
BARRA EN ALUMINIO

BARRA-BAR-BARRA  
3006-23530

**KOMORI SPRINT & LITHRONE 25/26/28**  
vecchio modello-old model-modelo viejo

BARRA IN ALLUMINIO  
ALUMINIUM BAR  
BARRA EN ALUMINIO

BARRA-BAR-BARRA  
3042-18292

**KOMORI LITHRONE 40/44/50**  
vecchio modello-old model-modelo viejo

BARRA IN ALLUMINIO  
ALUMINIUM BAR  
BARRA EN ALUMINIO

BARRA-BAR-BARRA  
19070



# ROYAL UNDERBLANKET®

THE MOST COMPLETE PROGRAMME  
OF THICKNESSES IN THE WORLD

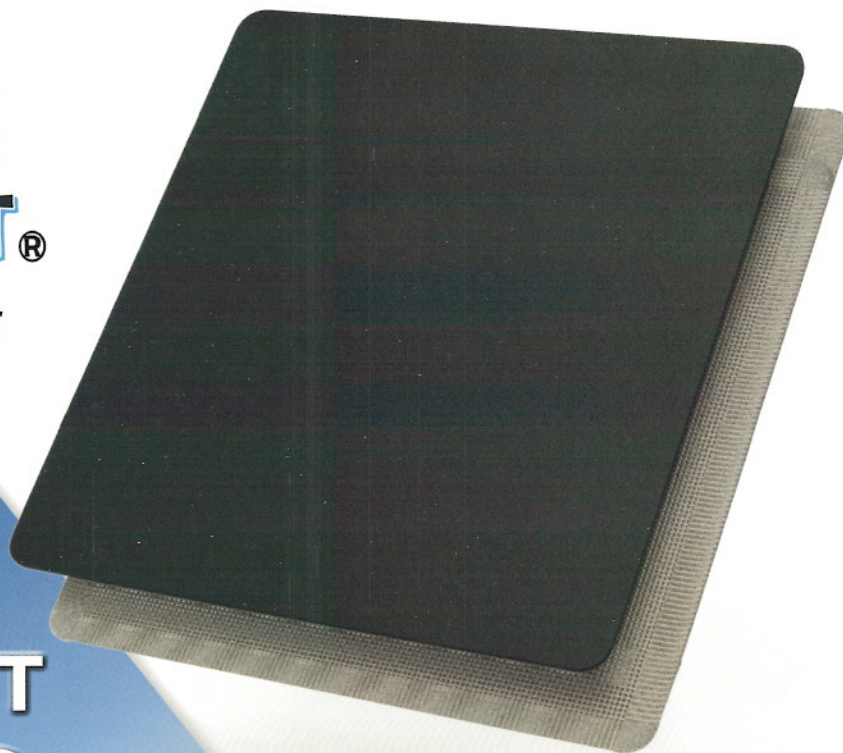

**THE ONLY  
UNDERBLANKET  
WITH GROUND  
RUBBER SURFACE**

**- MAXIMUM PRECISION  
AND DURABILITY -**

**HARDNESS:**

**75 SHORE**

**THICKNESSES  
AVAILABLE:**

MM: 0,35 - 0,40 - 0,45  
0,50 - 0,55 - 0,60 - 0,65  
0,70 - 0,75 - 0,80 - 0,90  
1,00 - 1,05 - 1,10 - 1,15  
1,20 - 1,25 - 1,30 - 1,35  
1,40 - 1,45 - 1,50 - 1,70.

**TOLERANCE:**

**+/-0,02**

**AVAILABLE IN CUT PIECES AND IN ROLLS**





# SUPER-PACK®

**CARTONCINI CALIBRATI DI ALTA QUALITÀ E PRECISIONE - I PRIMI CARTONCINI "CERTIFICATI" AL MONDO**  
**HIGH QUALITY AND PRECISION UNDERPACKING PAPER - THE FIRST CERTIFIED UNDERPACKING PAPERS IN THE WORLD**  
**ALZAS CALIBRADAS DE ALTA CALIDAD Y PRECISION - LOS PRIMEROS PAPELES CALIBRADOS "CERTIFICADOS" EN EL MUNDO**



Speciale trattamento repellenza al solvente  
*Special solvent - repellent treatment*  
 Tratamiento especial repelente al solvente



MISURE STANDARD "UFFICIALI"  
 "OFFICIAL" STANDARD SIZES  
 MEDIDAS ESTANDAR "OFICIALES"



**SUPER-PACK®**

DOPO 30 MINUTI . AFTER 30 MINUTES . DESPUES DE 30 MINUTOS

PRODOTTO CONCORRENTE "MADE IN GERMANY" . COMPETITOR'S PRODUCT "MADE IN GERMANY"  
 PRODUCTO DE LA COMPETENCIA "MADE IN GERMANY"

DOPO 30 MINUTI . AFTER 30 MINUTES . DESPUES DE 30 MINUTOS

KOMORI LITHRONE 28 / 428 / 528 / 628 / 828	730 x 555
KOMORI LITHRONE 29	760 x 570
KOMORI LITHRONE 40 / 440 / 540 / 640 / 840	1030 x 755
KOMORI LITHRONE SX40	1050 x 765
KOMORI LITHRONE S44	1145 x 860

PRODOTTO DI ORIGINE ASIATICA . PRODUCT OF ASIAN ORIGIN . PRODUCTO DE ORIGEN ASIATICO  
 DOPO POCHI SECONDI . AFTER A FEW SECONDS . DESPUES DE POCOS SEGUNDOS

**LA PIÙ VASTA GAMMA DI CARTONCINI CALIBRATI AL MONDO!**  
**THE LARGEST RANGE OF CALIBRATED PAPER IN THE WORLD!**  
**¡LA MAYOR GAMA DE TARJETAS CALIBRADAS DEL MUNDO!**



**SEVERE VERIFICHE PER IL CONTROLLO DELLO STANDARD QUALITATIVO  
PRECISE MEASUREMENTS ARE MADE TO CHECK THE QUALITY STANDARD  
SEVERAS COMPROBACIONES PARA EL CONTROL DE CALIDAD**

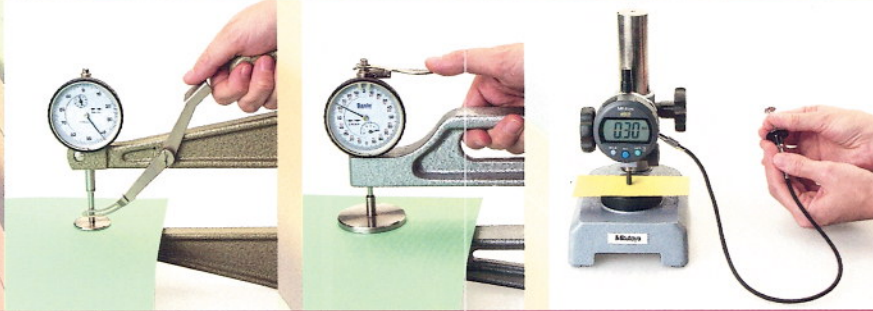

**SPessori  
DISPONIBILI  
THICKNESSES  
AVAILABLE  
ESPEsoRES  
DISPONIBLES**

mm	my	inch	
0,05	50	002"	ROSA / PINK / ROSA
0,075	75	003"	VERDE ACQUA / AQUAMARINE / AGUAMARINA
0,10	100	004"	AVORIO / IVORY / MARFIL
0,125	125	005"	SALMONE / SALMON / SALMÓN
0,15	150	006"	MARRONE / BROWN / MARRON
0,175	175	007"	CORALLO / CORAL / CORAL
0,20	200	008"	VERDE / GREEN / VERDE
0,25	250	010"	ARANCIO / ORANGE / NARANJA
0,30	300	012"	GIALLO / YELLOW / AMARILLO
0,35	350	014"	PISTACCHIO / PISTACHIO / PISTACHO
0,40	400	016"	AZZURRO / LIGHT BLUE / AZUL
0,50	500	020"	GRIGIO / GREY / GRIS

**I CARTONCINI CALIBRATI "SUPER PACK"  
VENGONO FORNITI STESI IN BOX DI CARTONE  
CON RINFORZI LATERALI IN LEGNO**

**THE "SUPER PACK" UNDERPACKING PAPERS  
ARE SUPPLIED PACKED FLAT IN CARDBOARD  
BOXES WITH LATERAL WOODEN SUPPORTS**

**LOS PAPELES CALIBRADOS "SUPER PACK"  
SE SUMINISTRAN PLANOS, EN CAJAS DE CARTON  
CON REFUERZOS LATERALES DE MADERA**





MAXIMUM  
PRECISION AND  
DURABILITY

N.T.L.T.®  
No Thickness Loss Technology

# PATENTED HIGHLANDER PACK INFINITY® STRUCTURAL UNDERPACKING "INDESTRUCTIBLE"

FOR A VERY HIGH PRINT QUALITY  
THE PRECISION OF THE "PACK" IS VERY IMPORTANT ... BUT OFTEN UNDERESTIMATED !

JUST APPLY THESE FOUR RULES  
TO GET A "PERFECT PACK"

- 1 CAREFULLY CONSULT THE MACHINE MANUAL  
IN ORDER TO IDENTIFY THE EXACT THICKNESS  
OF THE "PACK" TO USE.



## "PACK" TRADITIONAL METHOD

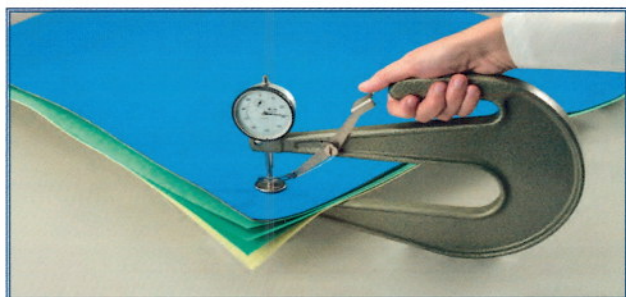

- 2 RESPECT PERFECTLY  
THE THICKNESS OF THE "PACK"  
MEASURING WITH A MICROMETRE EACH  
INDIVIDUAL COMPONENT OF THE UNDERPACKING USED.

- 3 DO NOT INCREASE THE THICKNESS  
OF THE "PACK" !  
AN EXCESSIVE THICKNESS OF THE "PACK"  
WILL RESULT IN A SIGNIFICANT REDUCTION OF  
THE PRINT QUALITY AND THE BLANKET WILL BE  
MARKED AND WILL KEEP THE TRACES OF  
THE PREVIOUS PRINT JOB .

INCORRECT PACK  
Increased pack thickness

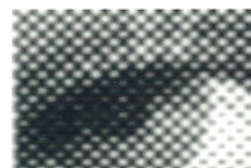
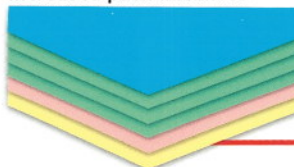

PRINT RESULT

CORRECT PACK  
Exact pack thickness as  
indicated in the machine manual

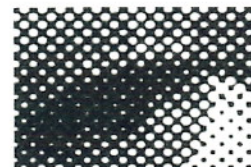
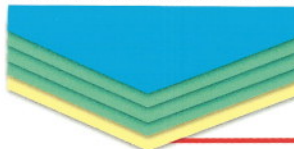

PRINT RESULT

## "PACK" WITH HIGHLANDER INFINITY®

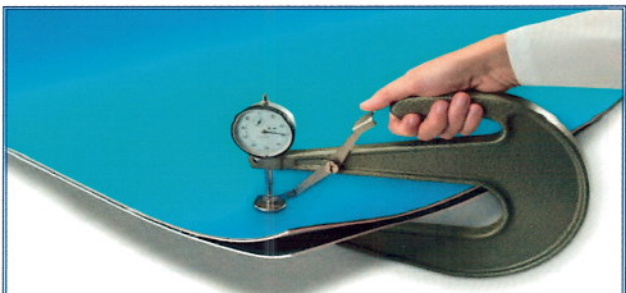

- 4 HOW TO OBTAIN THE "PERFECT PACK":  
THE USE OF OUR PRINTING BLANKETS PRODUCED  
WITH N.T.L.T. (No Thickness Loss Techno-  
logy) WITH THE STRUCTURAL UNDERPACKING

**HIGHLANDER PACK INFINITY®** guarantees  
precisely the exact thickness of the "PACK" as indicated  
in the press manual and the maintaining of the thickness  
for a large number of production runs.



# PATENTED HIGHLANDER PACK INFINITY®

**THE ONLY STRUCTURAL UNDERPACKING  
FOR PRINTING BLANKETS  
WITH HIGH DIMENSIONAL STABILITY  
AND A GROUND SURFACE  
(KEEPS THE THICKNESS STABLE)**

**HIGHLANDER** is an innovative non-deformable underpacking that can be used under any printing blanket with the purpose of obtaining the absolutely **precise** thickness (Pack) in conformity with the indications in all the machine manufacturers' manuals.

The **Precision** and the **Maintaining** of the thickness are the most important characteristics of **HIGHLANDER** which differentiate it from any other similar product in the world and which guarantee a superior quality of dot printing.

**HIGHLANDER PACK INFINITY® NON-ADHESIVE** is produced in the following thicknesses:

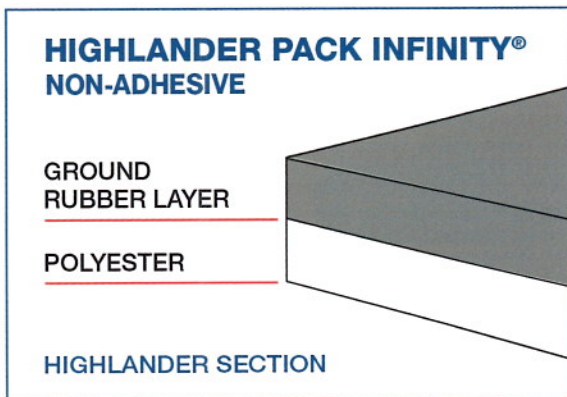

0.65mm  
0.70mm  
0.75mm  
0.80mm  
0.85mm  
0.90mm  
0.95mm  
1.00mm  
1.10mm  
1.15mm  
1.30mm  
1.35mm  
1.40mm  
1.45mm  
1.50mm

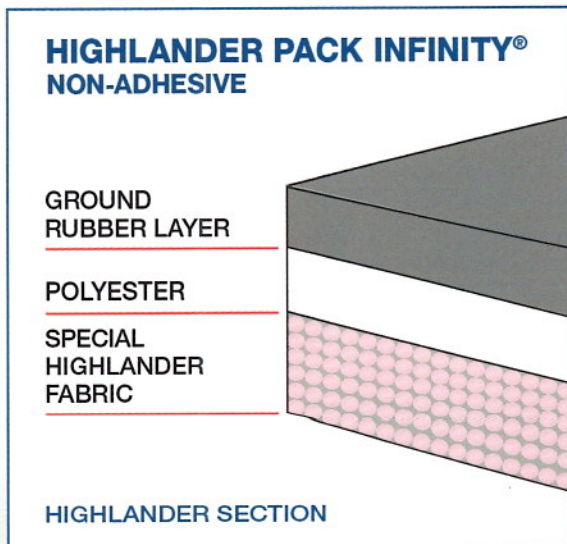

**HIGHLANDER PACK INFINITY® NON-ADHESIVE** is supplied in cut sheets and in rolls.

**HIGHLANDER** is manufactured using a special production system which guarantees a real dimensional stability superior to all other materials present in the market.

The dimensional stability of **HIGHLANDER** guarantees the complete maintaining of the thickness of all the Pack, ensuring a longer working life than any other system in use today.

**HIGHLANDER** is the only underpacking manufactured with the surface totally ground, thus guaranteeing a greater durability that is not comparable with any other known system.

**HIGHLANDER PACK INFINITY®** is made using a special fabric structure coupled with a layer of polyester and a layer of rubber.

**NEW!!**

**HIGHLANDER PACK INFINITY®  
ADHESIVE VERSION NOW AVAILABLE!**

**HIGHLANDER PACK INFINITY® ADHESIVE** is produced in the following thicknesses:

0.65mm  
0.70mm  
0.75mm  
0.80mm  
0.85mm

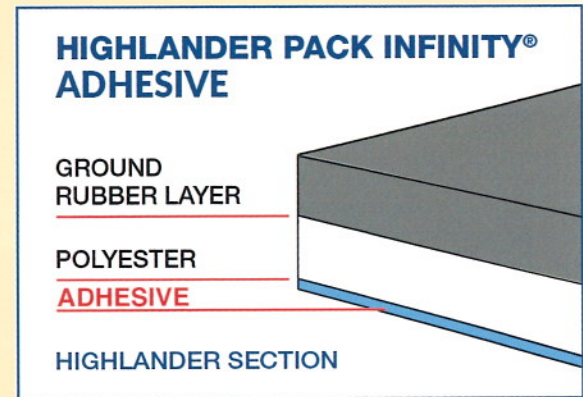

0.90mm  
0.95mm  
1.00mm  
1.05mm  
1.10mm  
1.15mm  
1.20mm  
1.25mm  
1.30mm  
1.35mm  
1.40mm  
1.45mm  
1.50mm



**HIGHLANDER PACK INFINITY® ADHESIVE** is supplied in cut sheets.



**ARTICOLI VARI  
SUNDRIES  
ARTICULOS VARIOS**

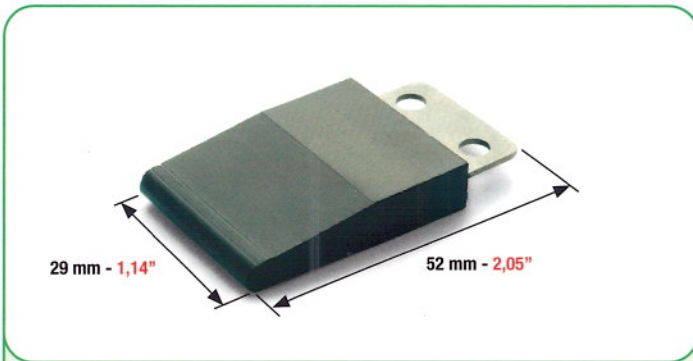
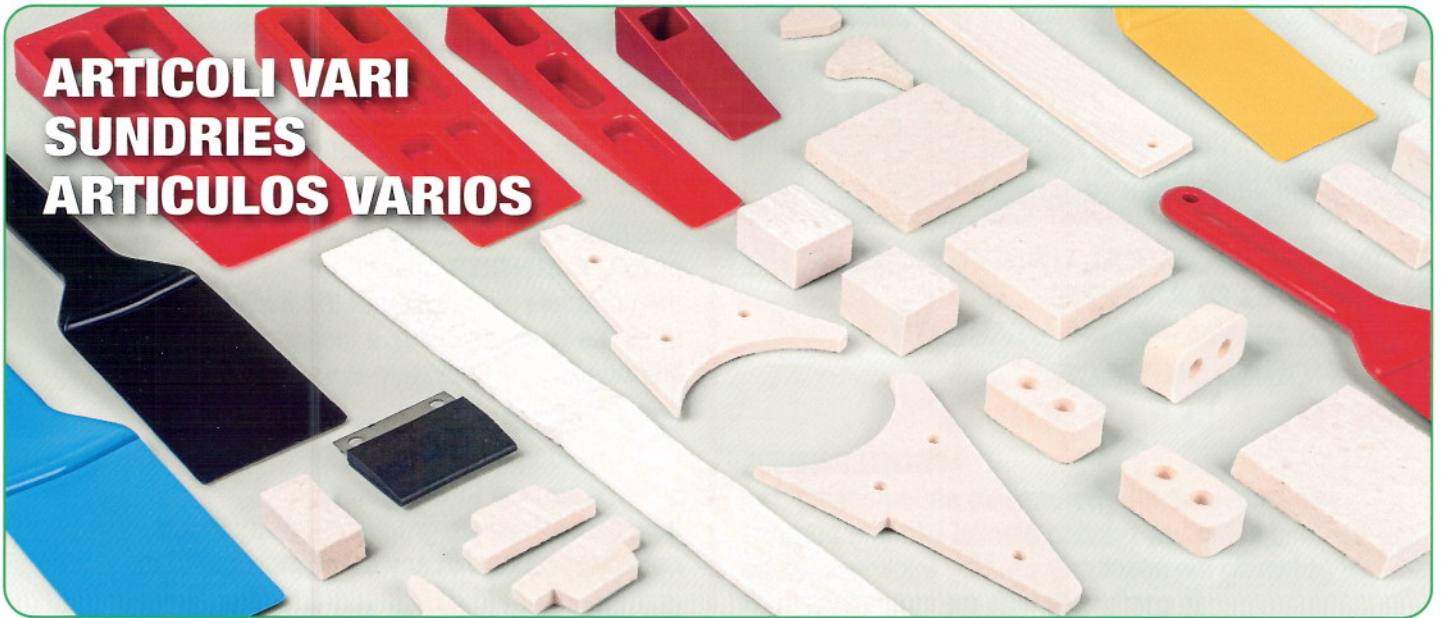

**RACCOGLI GRUMI PER:  
HICKEY REMOVER FOR:  
QUITAMOTAS PARA:**

**KOMORI LITHRONE 40/440/540/640/840  
TUTTI I MODELLI - ALL MODELS - TODOS LOS MODELOS**

ORDINE MINIMO 5 PEZZI  
MINIMUM ORDER 5 PCS  
PEDIDO MÍNIMO 5 PIEZAS

CODICE  
CODE - CÓDIGO

**3820**

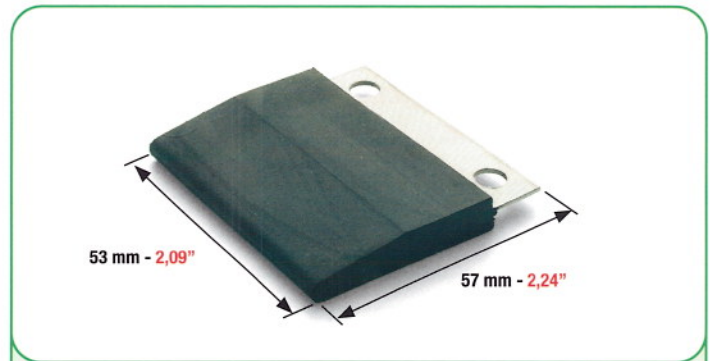

**RACCOGLI GRUMI PER:  
HICKEY REMOVER FOR:  
QUITAMOTAS PARA:**

**KOMORI LITHRONE 50/550/650  
TUTTI I MODELLI - ALL MODELS - TODOS LOS MODELOS**

ORDINE MINIMO 5 PEZZI  
MINIMUM ORDER 5 PCS  
PEDIDO MÍNIMO 5 PIEZAS

CODICE  
CODE - CÓDIGO

**3825**

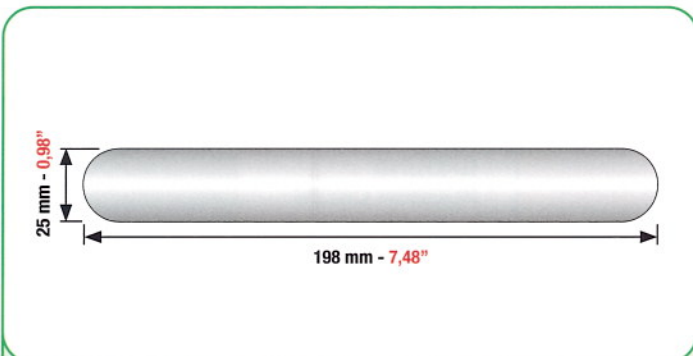

**LAMETTA CALBRATA PER LA REGOLAZIONE DELLA PRESSIONE  
DEI RULLI INCHIOSTRATORI  
GAUGED STEEL BLADE FOR ADJUSTMENT OF INKING ROLLER PRESSURE  
CUCHILLA PEQUEÑA EN ACERO, CALBRADA PARA LA REGULACIÓN  
DE LA PRESIÓN DE LOS RODILLOS ENTINTADORES**

CONFEZIONE 4 PEZZI  
4 PCS PACKET  
CONFECCIONES DE 4 PIEZAS

CODICE  
CODE - CÓDIGO

**4630**

SPESSORE  
THICKNESS - GROSOR

0,10 mm 0,004"

**MORBIDO - SOFT - BLANDO**

**Special**

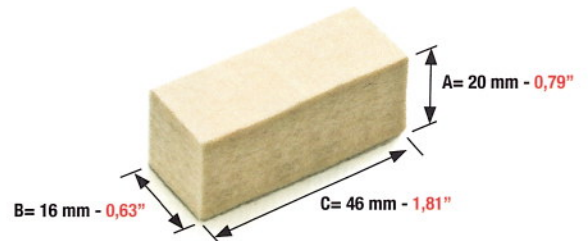

**FELTRINO PER PULIZIA ANELLI PER:  
FELT FOR CLEANING RINGS FOR:  
FILTRO PEQUEÑO PARA LA LIMPIEZA DE ANILLOS PARA:**

**KOMORI LITHRONE 26**

CONFEZIONE DA 20 PEZZI  
PACKET OF 20 PCS  
CONFECCIÓN DE 20 PIEZAS

CODICE  
CODE - CÓDIGO

**5165-A**



MORBIDO - SOFT - BLANDO

Special

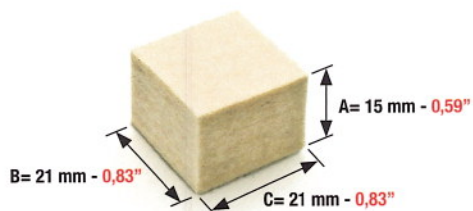

FELTRINO PER PULIZIA ANELLI PER:  
FELT FOR CLEANING RINGS FOR:  
FIELTRO PEQUEÑO PARA LA LIMPIEZA DE ANILLOS PARA:

**KOMORI LITHRONE 28/228/428/528**

CONFEZIONE DA 20 PEZZI  
PACKET OF 20 PCS  
CONFECCIÓN DE 20 PIEZAS

CODICE  
CODE - CÓDIGO

**5165**

MORBIDO - SOFT - BLANDO

Special

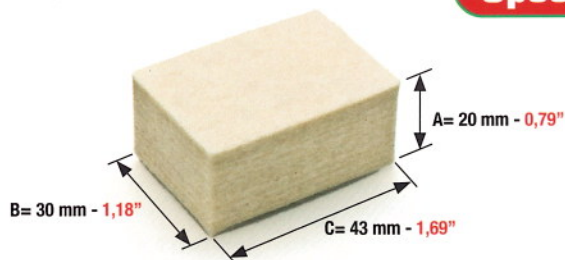

FELTRINO PER PULIZIA ANELLI PER:  
FELT FOR CLEANING RINGS FOR:  
FIELTRO PEQUEÑO PARA LA LIMPIEZA DE ANILLOS PARA:

**KOMORI LITHRONE G40 H-UV**

CONFEZIONE DA 20 PEZZI  
PACKET OF 20 PCS  
CONFECCIÓN DE 20 PIEZAS

CODICE  
CODE - CÓDIGO

**5121-B**

MORBIDO - SOFT - BLANDO

Special

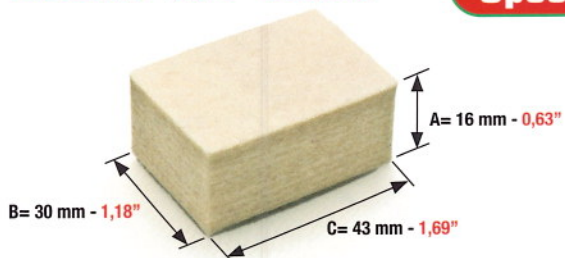

FELTRINO PER PULIZIA ANELLI PER:  
FELT FOR CLEANING RINGS FOR:  
FIELTRO PEQUEÑO PARA LA LIMPIEZA DE ANILLOS PARA:

**KOMORI LITHRONE 40/440/540/640/840**

CONFEZIONE DA 20 PEZZI  
PACKET OF 20 PCS  
CONFECCIÓN DE 20 PIEZAS

CODICE  
CODE - CÓDIGO

**5121**

MORBIDO - SOFT - BLANDO

Special

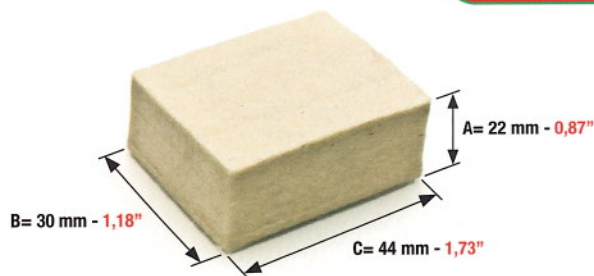

FELTRINO PER PULIZIA ANELLI PER:  
FELT FOR CLEANING RINGS FOR:  
FIELTRO PEQUEÑO PARA LA LIMPIEZA DE ANILLOS PARA:

**KOMORI LITHRONE S 44**

CONFEZIONE DA 20 PEZZI  
PACKET OF 20 PCS  
CONFECCIÓN DE 20 PIEZAS

CODICE  
CODE - CÓDIGO

**5121-A**

MORBIDO - SOFT - BLANDO

Special

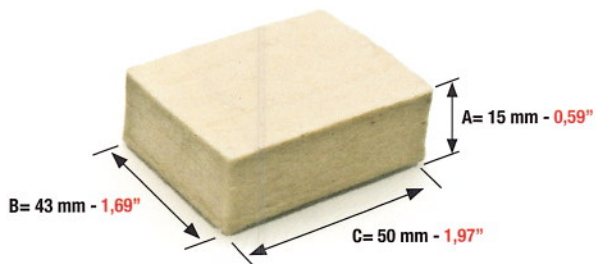

FELTRINO PER PULIZIA ANELLI PER:  
FELT FOR CLEANING RINGS FOR:  
FIELTRO PEQUEÑO PARA LA LIMPIEZA DE ANILLOS PARA:

**KOMORI LITHRONE 50/550/650/850**

CONFEZIONE DA 20 PEZZI  
PACKET OF 20 PCS  
CONFECCIÓN DE 20 PIEZAS

CODICE  
CODE - CÓDIGO

**5129**

MORBIDO - SOFT - BLANDO

Special

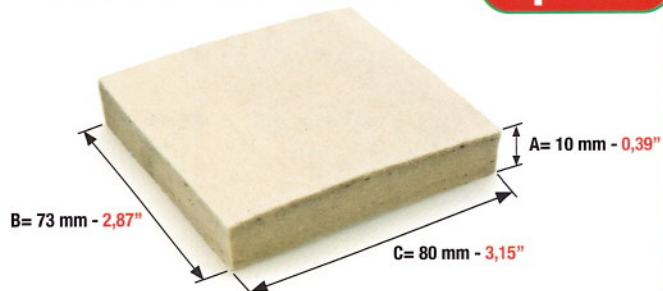

FELTRINO PER PULIZIA ANELLI PER:  
FELT FOR CLEANING RINGS FOR:  
FIELTRO PEQUEÑO PARA LA LIMPIEZA DE ANILLOS PARA:

**KOMORI CHAMBON 101 D4**

CONFEZIONE DA 20 PEZZI  
PACKET OF 20 PCS  
CONFECCIÓN DE 20 PIEZAS

CODICE  
CODE - CÓDIGO

**5152**



**MORBIDO - SOFT - BLANDO**

**Special**

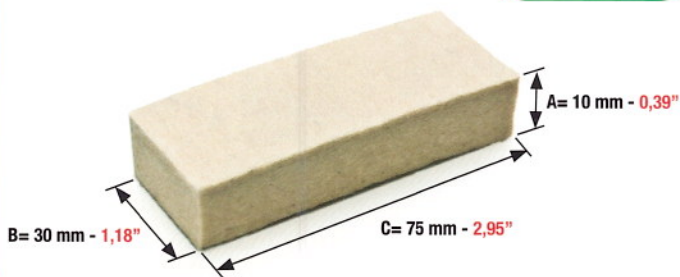

FELTRINO PER PULIZIA ANELLI PER:  
FELT FOR CLEANING RINGS FOR:  
FIELTRO PEQUEÑO PARA LA LIMPIEZA DE ANILLOS PARA:

**KOMORI CHAMBON**

CONFEZIONE DA 20 PEZZI  
PACKET OF 20 PCS  
CONFECCIÓN DE 20 PIEZAS

CODICE  
CODE - CÓDIGO

**5175**

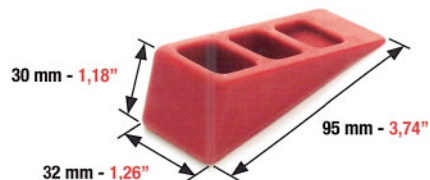

MISURA - SIZE - MEDIDA  
mm 30 x 32 x 95

**CUNEO MINI**  
MINI PLASTIC WEDGE  
CUÑA MINI

**BABY**

CODICE  
CODE - CÓDIGO

**5143**

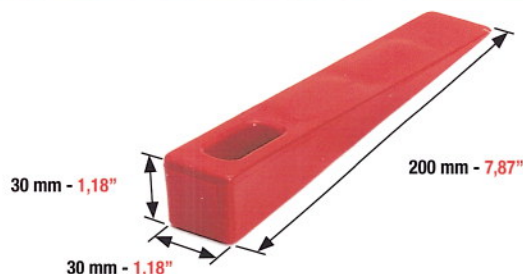

MISURA - SIZE - MEDIDA  
mm 30 x 30 x 200

**CUNEO PICCOLO**  
SMALL PLASTIC WEDGE  
CUÑA PEQUEÑA

**SMALL**

CODICE  
CODE - CÓDIGO

**5145**

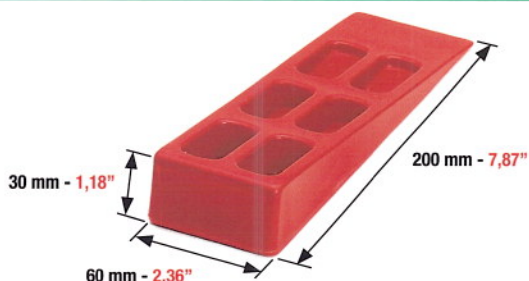

MISURA - SIZE - MEDIDA  
mm 30 x 60 x 200

**CUNEO MEDIO**  
MEDIUM PLASTIC WEDGE  
CUÑA MEDIANA

**MEDIUM**

CODICE  
CODE - CÓDIGO

**5150**



MISURA - SIZE - MEDIDA  
mm 25 x 75 x 200

**CUNEO GRANDE**  
LARGE PLASTIC WEDGE  
CUÑA GRANDE

**LARGE**

CODICE  
CODE - CÓDIGO

**5155**



**NEW**

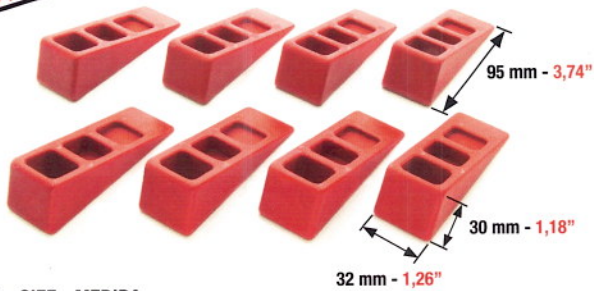

MISURA - SIZE - MEDIDA  
mm 30 x 32 x 95

SET COMPOSTO DA 8 CUNEI MINI DI UGUALE MISURA  
SET OF 8 MINI WEDGES OF THE SAME SIZE  
JUEGO COMPUESTO POR 8 CUÑAS MINI DE IGUAL TAMAÑO

**SET "0" (BABY)**

CODICE - CODE - CÓDIGO

**5132**

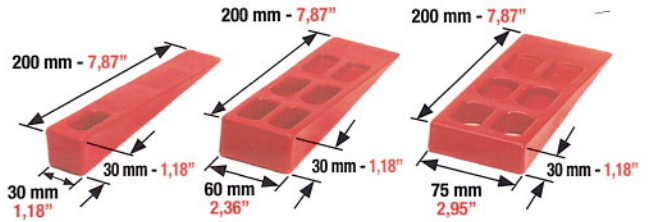

MISURE - SIZES - MEDIDAS  
mm 30 x 30 x 200  
mm 30 x 60 x 200  
mm 25 x 75 x 200

SET COMPOSTO DA 3 CUNEI DI DIVERSA MISURA  
SET OF 3 WEDGES OF DIFFERENT SIZES  
JUEGO COMPUESTO POR 2 CUÑAS DE TAMAÑO GRANDE

**SET "1" (STANDARD)**

CODICE - CODE - CÓDIGO

**5130**

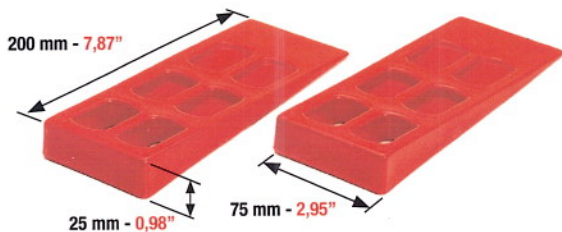

MISURE - SIZES - MEDIDAS  
mm 25 x 75 x 200

SET COMPOSTO DA 2 CUNEI DI MISURA GRANDE  
SET OF 2 LARGE WEDGES  
JUEGO COMPUESTO POR 2 CUÑAS DE TAMAÑO GRANDE

**SET "2"**

CODICE - CODE - CÓDIGO

**5135**

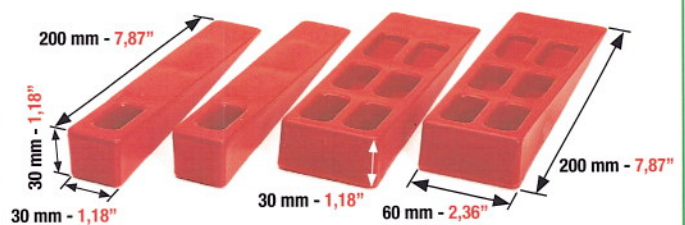

MISURE - SIZES - MEDIDAS  
mm 30 x 30 x 200  
mm 30 x 60 x 200

SET COMPOSTO DA 2 CUNEI PICCOLI + 2 MEDI  
SET OF 2 SMALL + 2 MEDIUM WEDGES  
JUEGO COMPUESTO POR 2 CUÑAS PEQUEÑAS + 2 MEDIAS

**SET "3"**

CODICE - CODE - CÓDIGO

**5140**



**TOP QUALITY**

**STANDARD SIZE**



SPATOLE IN PLASTICA PER INCHIOSTRO PER CALAMAI CON SENSORI "CPC"  
PLASTIC INK SPATULAS FOR "CPC" DUCT  
ESPATULAS DE PLASTICO PARA LA TINTA DE LOS TINTEROS CON SENSORES "CPC"

SCATOLE COMPOSTE DA 4 SPATOLE (GIALLO ROSSO BLU NERO)  
BOXES CONTAIN 4 SPATULAS (YELLOW RED BLUE BLACK)  
CAJA CON 4 ESPATULAS (AMARILLO ROJO AZUL NEGRO)

CODICE  
CODE - CÓDIGO

**5095**



**PERSONALIZZARE LE SPATOLE**  
LE NOSTRE SPATOLE POSSONO  
ESSERE PRODOTTE CON IL VOSTRO  
MARCHIO COMMERCIALE  
STAMPATO SUL MANICO.  
(RICHIESTE MAGGIORI INFORMAZIONI)

**PERSONALISE THE SPATULAS**  
OUR SPATULAS CAN BE PRODUCED  
WITH YOUR COMPANY NAME  
AND LOGO PRINTED ON THE HANDLE  
(ASK FOR MORE DETAILS)

**PERSONALIZAR LAS ESPATULAS**  
TODAS NUESTRAS ESPATULAS  
SE PUEDEN SUMINISTRAR  
CON SU MARCA COMERCIAL  
IMPRESA EN EL MANGO  
(SOLICITE MAYOR INFORMACION)



Copricalamaio per macchine  
 Cubretinteros para maquinas  
 Ink duct foils for

**KOMORI**  
 BREVETTATO PATENTED

**PATENTADO**

# Perfecto!

TM

ESCLUSIVA MONDIALE  
 WORLDWIDE EXCLUSIVE  
 EXCLUSIVA MONDIAL

CODE	KOMORI	SIZE A IN MM	SIZE D IN MM
18100	PERFECTO® - KOMORI LITHRONE 20 "PQC" (YEAR 1999)	114	543
18101	PERFECTO® - KOMORI LITHRONE 20 (YEAR 2001)	104	525
18105	PERFECTO® - KOMORI LITHRONE 26	128	673
18110	PERFECTO® - KOMORI LITHRONE 28 (2000 SERIES) OLD MODEL	160	735
18110A	PERFECTO® - KOMORI L28 (2000 SERIES) OLD MODEL (MODIFIED BEND)	160	732
18115	PERFECTO® - KOMORI LITHRONE 28 NY(3000 SERIES) NEW MODEL	111	769
18120	PERFECTO® - KOMORI LITHRONE 29 SPICA/LSX529 / 629 / 829	128	769
18121	PERFECTO® - KOMORI LITHRONE A37	128	984
18123	PERFECTO® - KOMORI LITHRONE 40 (OLD MODEL - UP TO 1995)	150	1035
18124	PERFECTO® - KOMORI L G40-40P-GX40RP	135	1058
18124A	PERFECTO® - KOMORI L G40-40P-GX40RP	135	1056
18125	PERFECTO® - KOMORI LITHRONE 40 - L40 - L40P	162	1086
18130	PERFECTO® - KOMORI LITHRONE S40/ S440/ S540/ S640	136	1089,5
18132	PERFECTO® - KOMORI LITHRONE S40P/ S540P/ S640P/ S840P	136	1058,5
18137	PERFECTO® - KOMORI LITHRONE 50/450/550	174	1361
18137	PERFECTO® - KOMORI LITHRONE 50/450/550	174	1361

I continui cicli di lavorazione e i frequenti cambi di inchiostro richiedono una costante attenzione del calamaio che deve risultare sempre ben pulito, privo di accumuli e residui di inchiostro essiccato. Tale attenzione comporta ripetute operazioni di lavaggio molto accurate e la rimozione di eventuali parti essiccate, da eseguire manualmente, ad ogni cambio di inchiostro. Queste operazioni procurano notevoli tempi di fermo macchina incidendo fortemente sulla mancata produttività. I copricalamaio "Perfecto"™ aiutano a ridurre notevolmente i tempi di inoperatività garantendo agli operatori maggior facilità, rapidità e flessibilità nei vari cicli produttivi.

Continuous work cycles and frequent ink changes require the constant attention of the ink duct, which must always be well cleaned, free of any accumulations or residues of dried ink. This attention necessitates repeated and careful wash operations and the removal of any dried dirt, which has to be done manually every time you change the ink. These cleaning operations cause considerable downtimes which significantly reduce the productivity of the press. The "Perfecto"™ duct foils help to considerably shorten the periods of non-productivity, guaranteeing the operators a greater ease, speed and flexibility in the various production cycles.

Los continuos ciclos de trabajo y los frecuentes cambios de tinta precisan de una constante atención sobre el tintero, que debe estar siempre limpio sin que hayan acumulados residuos de tinta seca. Esta atención comporta repetidas operaciones de lavado muy a fondo para eliminar los eventuales residuos secos, haciéndolo manualmente, en cada cambio de tinta. Estas operaciones provocan notables tiempos de paradas de maquina, incidiendo fuertemente sobre la falta de productividad. Los cubretinteros "Perfecto"™ ayudan a reducir notablemente los tiempos de parada de maquina, garantizando al operario una mayor facilidad, rapidez y flexibilidad en los varios ciclos productivos.

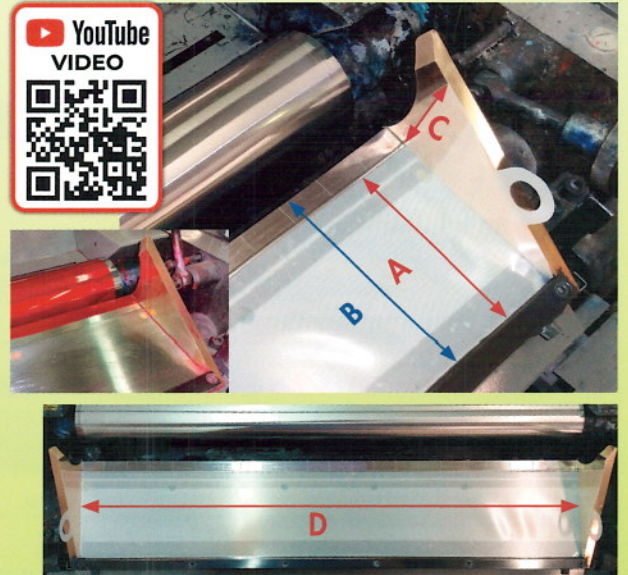





# ROYAL CLEANING PRODUCTS®





**Economic**

10620 - 1000 cc

10625 - 1000 cc

10610 - 500 cc

10615 - 500 cc

BOTTIGLIE DI LAVAGGIO ECONOMICHE  
CON BECCUCCIO DIRITTO O CURVO DA 500 E 1000 CC

ECONOMICAL WASH BOTTLES  
WITH STRAIGHT OR BENT SPOUT - 500 CC AND 1000 CC

BOTELLA DE LAVADO ECONOMICA  
CON TUBO RECTO O CURVADO DE 500 Y 1000 CC

CODICE - CODE - CÓDIGO

10610 / 10615

10620 / 10625

**Top Quality**

BOTTIGLIE DI LAVAGGIO DI ALTA QUALITÀ E RESISTENZA  
AI VARI SOLVENTI - 1000 CC

HIGH QUALITY SOLVENT-RESISTANT WASH BOTTLES - 1000 CC

BOTELLA DE LAVADO DE ALTA CALIDAD Y RESISTENCIA  
A SOLVENTES VARIOS DE 1000 CC

CODICE - CODE - CÓDIGO

10600



CONFEZIONE DA 12 PEZZI  
PACKET OF 12 PCS  
CONFECCION DE 12 UNIDADES



## SUPER GLOVES PROFESSIONAL

GUANTI SPECIALI IN NITRILE DI ALTISSIMA QUALITÀ RESISTENTI AGLI ACIDI ED AI SOLVENTI

SPECIAL HIGH QUALITY NITRILE GLOVES RESISTANT TO ACIDS AND SOLVENTS

GUANTES ESPECIALES DE NITRILLO DE ALTISIMA CALIDAD, RESISTENTES A LOS ACIDOS Y SOLVENTES

CODICE  
CODE - CÓDIGO

10660

10662

10664

MISURA - SIZE - MEDIDA

8

9

10

**TOP QUALITY**  
**ORIGINAL**



## ROYAL SPONGES

SPUGNE PRESSATE DI ALTISSIMA QUALITÀ

TOP QUALITY COMPRESSED SPONGES

ESPONJAS PRENSADA DE ALTISIMA CALIDAD

CONFEZIONE DA 10 PEZZI  
PACKET OF 10 PCS  
CONFECCION DE 10 UNIDADES

DIMENSIONI - SIZE - TAMAÑO

140 x 95 x 35 mm

140 x 95 x 32 mm

CODICE - CODE - CÓDIGO

10651

10652

## SUPER SCRUBBER

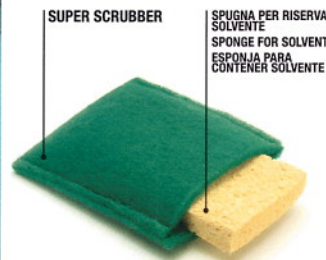
**Strong**

FIBRA ABRASIVA SPECIALE PER LA PULIZIA IN PROFONDITÀ DI TESSUTI GOMMATI MOLTO SPORCHI COMPLETA DI SPUGNA PER IL SOLVENTE

SPECIAL ABRASIVE FIBRE FOR DEEP CLEANING OF VERY DIRTY PRINTING BLANKETS, COMPLETE WITH SPONGE FOR SOLVENT

FIBRA ABRASIVA ESPECIAL PARA LA LIMPIEZA EN PROFUNDIDAD DE CAUCHOS MUY SUCIOS, CON ESPONJA PARA EL SOLVENTE

ORDINE MINIMO 4 PEZZI  
MINIMUM ORDER 4 PCS  
PEDIDO MINIMO 4 PIEZAS

CODICE - CODE - CÓDIGO

10640



**SUPER SCRUBBER**  
*white*

**Soft**

SUPER SCRUBBER *white*

SPUGNA PER RISERVA SOLVENTE  
SPONGE FOR SOLVENT  
ESPONJA PARA CONTENER SOLVENTE

SPECIALE FIBRA SINTETICA NON ABRASIVA PER LA PULIZIA OTTIMALE DI TESSUTI GOMMATI MOLTO SPORCHI COMPLETA DI SPUGNA PER IL SOLVENTE  
SPECIAL SYNTHETIC NON-ABRASIVE FIBRE FOR THOROUGH CLEANING OF VERY DIRTY PRINTING BLANKETS, COMPLETE WITH SPONGE FOR SOLVENT  
FIBRA SINTETICA ESPECIAL NO ABRASIVA PARA LA PERFECTA LIMPIEZA DE CAUCHOS MUY SUCIOS, CON ESPONJA PARA EL SOLVENTE

ORDINE MINIMO 4 PEZZI MINIMUM ORDER 4 PCS PEDIDO MINIMO 4 PIEZAS	CODICE - CODE - CÓDIGO <b>10644</b>
--	--

**DUAL SUPER SCRUBBER**

**NEW** **1/2 Strong**  
**1/2 Soft**

SUPER SCRUBBER SOFT

SUPER SCRUBBER STRONG

SPUGNA PER RISERVA SOLVENTE  
SPONGE FOR SOLVENT  
ESPONJA PARA CONTENER SOLVENTE

FIBRA ABRASIVA (STRONG) E SPECIALE FIBRA SINTETICA NON ABRASIVA (SOFT) PER PULIZIA OTTIMALE DI TESSUTI GOMMATI MOLTO SPORCHI COMPLETA DI SPUGNA PER IL SOLVENTE  
ABRASIVE FIBRE (STRONG) AND SPECIAL SYNTHETIC NON-ABRASIVE FIBRE (SOFT) FOR THOROUGH CLEANING OF VERY DIRTY PRINTING BLANKETS COMPLETE WITH SPONGE FOR SOLVENT  
FIBRA ABRASIVA (STRONG) Y FIBRA SINTETICA ESPECIAL NO ABRASIVA (SOFT) PARA LA PERFECTA LIMPIEZA DE CAUCHOS MUY SUCIOS CON ESPONJA PARA EL SOLVENTE

ORDINE MINIMO 4 PEZZI MINIMUM ORDER 4 PCS PEDIDO MINIMO 4 PIEZAS	CODICE - CODE - CÓDIGO <b>10640-A</b>
--	--

**COMPACT SCRUB**

**Strong**

FIBRA ABRASIVA SPECIALE PER LA PULIZIA IN PROFONDITÀ DI TESSUTI GOMMATI MOLTO SPORCHI  
SPECIAL ABRASIVE FIBRE FOR DEEP CLEANING OF VERY DIRTY PRINTING BLANKETS  
FIBRA ABRASIVA ESPECIAL PARA LA LIMPIEZA EN PROFUNDIDAD DE CAUCHOS MUY SUCIOS

ORDINE MINIMO 4 PEZZI MINIMUM ORDER 4 PCS PEDIDO MINIMO 4 PIEZAS	CODICE - CODE - CÓDIGO <b>10642</b>
--	--

**COMPACT SCRUB**  
*white*

**Soft**

SPECIALE FIBRA SINTETICA NON ABRASIVA PER LA PULIZIA OTTIMALE DI TESSUTI GOMMATI MOLTO SPORCHI  
SPECIAL SYNTHETIC NON-ABRASIVE FIBRE FOR THOROUGH CLEANING OF VERY DIRTY PRINTING BLANKETS  
FIBRA SINTETICA ESPECIAL NO ABRASIVA PARA LA PERFECTA LIMPIEZA DE CAUCHOS MUY SUCIOS

ORDINE MINIMO 4 PEZZI MINIMUM ORDER 4 PCS PEDIDO MINIMO 4 PIEZAS	CODICE - CODE - CÓDIGO <b>10646</b>
--	--

**DUAL COMPACT SCRUB**

**1/2 Strong**  
**1/2 Soft**

**NEW**

SUPER SCRUBBER SOFT

SUPER SCRUBBER STRONG

FIBRA ABRASIVA (STRONG) E SPECIALE FIBRA SINTETICA NON ABRASIVA (SOFT) PER PULIZIA OTTIMALE DI TESSUTI GOMMATI MOLTO SPORCHI  
ABRASIVE FIBRE (STRONG) AND SPECIAL SYNTHETIC NON-ABRASIVE FIBRE (SOFT) FOR THOROUGH CLEANING OF VERY DIRTY PRINTING BLANKETS  
FIBRA ABRASIVA (STRONG) Y FIBRA SINTETICA ESPECIAL NO ABRASIVA (SOFT) PARA LA PERFECTA LIMPIEZA DE CAUCHOS MUY SUCIOS

ORDINE MINIMO 4 PEZZI MINIMUM ORDER 4 PCS PEDIDO MINIMO 4 PIEZAS	CODICE - CODE - CÓDIGO <b>10646-A</b>
--	--

**SIMPLE SCRUBBER**

**Strong**

29 mm - 1,14"

120 mm - 4,72"

90 mm - 3,54"

SPECIALE SPUGNA REALIZZATA DA UN LATO CON UNA FIBRA SINTETICA ABRASIVA E DA UN LATO CON VERA SPUGNA IN CELLULOSA. SPECIFICA PER LA PULIZIA IN PROFONDITÀ DI TESSUTI GOMMATI MOLTO SPORCHI.  
SPECIAL SPONGE MADE ON ONE SIDE WITH SYNTHETIC ABRASIVE FIBRE AND ON THE OTHER WITH REAL SPONGE IN CELLULOSE. SPECIFIC FOR DEEP CLEANING OF VERY DIRTY PRINTING BLANKETS.  
ESPONJA ESPECIAL REALIZADA DE UN LADO CON FIBRA SINTETICA ABRASIVA Y DEL OTRO CON ESPONJA VERDADERA IN CELLULOSA. ESPECIFICA PARA LA LIMPIEZA EN PROFUNDIDAD DE CAUCHOS MUY SUCIOS.

ORDINE MINIMO 4 PEZZI MINIMUM ORDER 4 PCS PEDIDO MINIMO 4 PIEZAS	CODICE - CODE - CÓDIGO <b>10647</b>
--	--



**SIMPLE SCRUBBER**

**Soft**



SPECIALE SPUGNA REALIZZATA DA UN LATO CON UNA FIBRA SINTETICA NON ABRASIVA E DA UN LATO CON VERA SPUGNA IN CELLULOSA. SPECIFICA PER LA PULIZIA OTTIMALE DI TESSUTI GOMMATI MOLTO SPORCHI.

SPECIAL SPONGE MADE ON ONE SIDE WITH SYNTHETIC NON-ABRASIVE FIBRE AND ON THE OTHER WITH REAL SPONGE IN CELLULOSE. SPECIFIC FOR PERFECT CLEANING OF VERY DIRTY PRINTING BLANKETS.

ESPONJA ESPECIAL REALIZADA DE UN LADO CON FIBRA SINTETICA NO ABRASIVA Y DEL OTRO CON ESPONJA VERDADERA IN CELLULOSA. ESPECIFICA PARA LA PERFECTA LIMPIEZA DE CAUCHOS MUY SUCIOS.

ORDINE MINIMO 4 PEZZI MINIMUM ORDER 4 PCS PEDIDO MINIMO 4 PIEZAS	CODICE - CODE - CÓDIGO <b>10648</b>
--	--

**SIMPLE SANDWICH SCRUBBER**

**1/2 Strong  
1/2 Soft**

**NEW**



DA UN LATO ABRASIVA (STRONG) E DA UN LATO NON ABRASIVA (SOFT), IN MEZZO SPUGNA IN CELLULOSA, PER PULIZIA OTTIMALE DI TESSUTI GOMMATI MOLTO SPORCHI

ON ONE SIDE ABRASIVE (STRONG) AND ON ONE SIDE NON-ABRASIVE (SOFT), IN THE MIDDLE SPONGE IN CELLULOSE, FOR PERFECT CLEANING OF VERY DIRTY PRINTING BLANKETS

DE UN LADO ABRASIVA (STRONG) Y DE OTRO NO ABRASIVA (SOFT), EN EL MEDIO ESPONJA IN CELLULOSA, PARA LA PERFECTA LIMPIEZA DE CAUCHOS MUY SUCIOS

ORDINE MINIMO 4 PEZZI MINIMUM ORDER 4 PCS PEDIDO MINIMO 4 PIEZAS	CODICE - CODE - CÓDIGO <b>10648-A</b>
--	--

# FOILTEX® WASHCLOTH PRODUCTS FOR MANUAL CLEANING

## FOILTEX PROGRAMME



CODE 27.22384 FOILTEX® BLU-TEX VERSION\* (68gr/sqm)  
 CODE 27.22384A FOILTEX® BLU-TEX MARINE VERSION\* (68gr/sqm)  
 CODE 27.22382 FOILTEX® WHITE-TEX VERSION (68gr/sqm)  
 CODE 27.22386 FOILTEX® SONTARA VERSION (68gr/sqm)

1 BOX = 500 CLOTHS  
 CLOTH SIZE: 400MM X 310MM  
 \* STANDARD = MOST FREQUENTLY SOLD



CODE 27.22389 FOILTEX® WHITE-TEX KING (100gr/sqm)

1 BOX = 400 CLOTHS  
 CLOTH SIZE: 400MM X 310MM



CODE 27.22383 FOILTEX® PERFECTING  
 SPECIFIC WASHCLOTH FOR MANUAL CLEANING OF SURFACES WITH ANTI-MARKING TREATMENT

1 BOX = 250 CLOTHS  
 CLOTH SIZE: 400MM X 310MM



CODE 27.22385  
**SUPERTEX MINI-ROLLS**  
 FOR MANUAL CLEANING

N. 650 TEAR-OFF CLOTHS  
 CLOTH SIZE: 400MM X 280MM

CODE 27.22388  
**SUPERTEX MINI-ROLLS**  
 FOR MANUAL CLEANING

NO TEAR-OFFS ON ROLL  
 ROLL SIZE: 230-260MM X 500MT  
 (The roll width may vary from 230-260mm depending on availability)



**NEW**

# ALL-TEX UNIVERSAL

**THE NEW MICRO-PERFORATED CLOTH  
FOR THE CLEANING OF ALL SURFACES !!**

**IL NUOVO PANNO MICROFORATO  
PER LA PULIZIA DI TUTTE LE SUPERFICI !!**

**EL NUEVO TEJIDO MICRO PERFORADO  
PARA LIMPIAR TODAS LAS SUPERFICIES ¡!**



**CODE 27.22381**  
**ALL-TEX® UNIVERSAL**  
**1 BOX = 300 CLOTHS**  
**CLOTH SIZE: 400MM X 310MM**

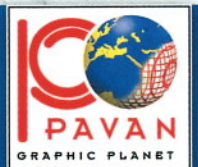



# folex<sup>®</sup>

# PACK FOIL



FILM POLIESTERE DA UTILIZZARE NEI CILINDRI PORTA LASTRE E PORTA CAUCCIÙ PER IL RAGGIUNGIMENTO OTTIMALE DEL "PACK" NELLE MACCHINE DA SPAMPA.



POLYESTER FOIL FOR PLATE AND BLANKET CYLINDERS TO OBTAIN OPTIMUM "PACK" ON THE PRINTING PRESS.



FILM DE POLIESTER PARA UTILIZAR EN LOS CILINDROS PORTAPLANCHA Y PORTACAUCHOS, PARA CONSEGUIR UNA OPTIMA MANTILLA "PACK" EN LA MAQUINA DE IMPRIMIR.

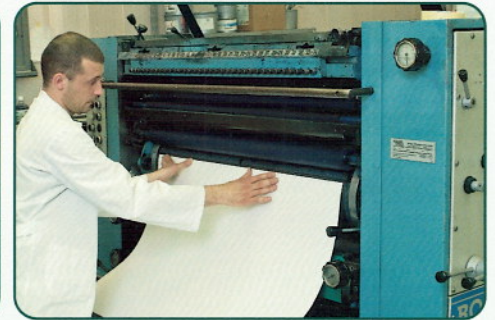
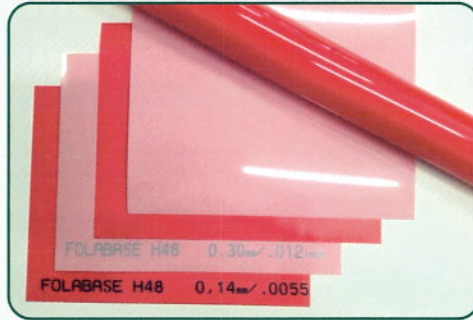

**SPessori  
THICKNESSES  
ESPORES**

**PACK-FOIL ADESIVO - PACK-FOIL ADHESIVE - PACK-FOIL ADHESIVO (FOLEX H 48)**

mm 0,08 - 0,10 - 0,12 - 0,14 - 0,16 - 0,18 - 0,20 - 0,21 - 0,22 - 0,23 - 0,24 - 0,25 - 0,26 - 0,28 - 0,30 - 0,32 - 0,35 - 0,40 - 0,45 - 0,50

**PACK-FOIL NON ADESIVO - PACK-FOIL NON-ADHESIVE - PACK-FOIL NO ADHESIVO (FOLABASE "U")**

mm 0,10 - 0,12 - 0,14 - 0,16 - 0,18 - 0,20 - 0,23 - 0,25 - 0,28 - 0,30 - 0,35

**PACK-FOIL PUÒ ESSERE FORNITO IN ROTOLO O IN QUALSIASI FORMATO RICHiesto  
PACK-FOIL CAN BE SUPPLIED IN ROLLS OR IN ANY SIZE OF CUT SHEETS YOU WISH TO REQUEST  
BAJO PEDIDO PODEMOS SUMINISTRAR EL PACK-FOIL EN ROLLOS O CORTADO EN CUALQUIER FORMATO**





# INK BIN® UNIVERSAL



## THE **UNIVERSAL** SYSTEM FOR **INK WASTE TRAY**

### INK BIN® UNIVERSAL MAKES THE DIFFERENCE:

*Without Ink Bin®, after several wash cycles the tray that collects the ink waste gets encrusted:*

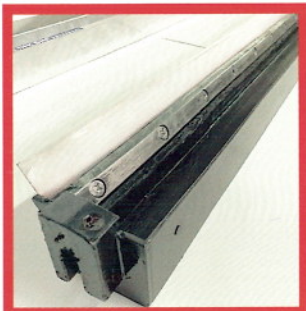

BEFORE

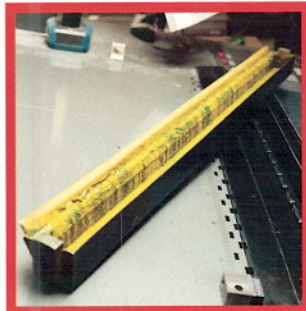

AFTER

COMPLETE WITH **MAGNET**  
TO GIVE MAXIMUM  
ADHERENCE TO THE TRAY



*With Ink Bin®:  
THE TRAY REMAINS PERFECT!!*

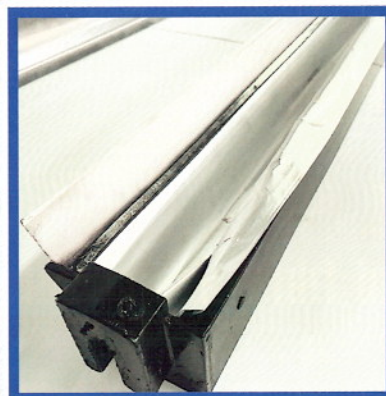

BEFORE

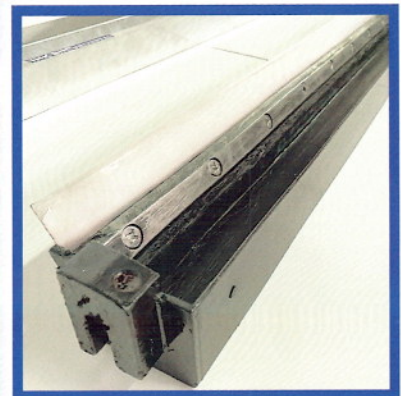

AFTER

Compatible with:

**KBA  
KOMORI  
HEIDELBERG  
MAN ROLAND  
AND MANY MORE!**

### THE ADVANTAGES OF INK BIN®:

- ✓ Maximum practicality and rapidity in installation
- ✓ Significant reduction of cleaning time
- ✓ Less downtime

# INK BIN®

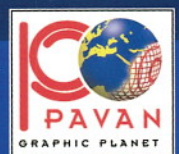



# PERFECT BLADES®

RACLE DI LAVAGGIO PER RULLI INCHIOSTRATORI  
WASH-UP BLADES FOR INK ROLLERS  
REGLETAS DE LAVADO PARA RODILLOS ENTINTADORES

**MR** = metal and rubber

**MRE** = metal and rubber "EPDM"

**P** = plastic

**R** = rubber

**V** = vulcollan for "UV INKS"   
top quality rubber for traditional inks

**T** = teflon for "UV INKS"  3 mm or 5 mm NORMAL

**ST** = shaped teflon for "UV INKS"



**PVC**

**SP** = special plastic



**FA** = laminated fibre and aluminium

**RA** = rubber and aluminium

**MRA** = metal and rubber coupled

**F** = laminated fibre

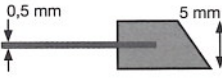
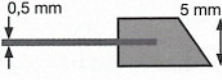
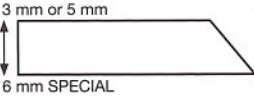
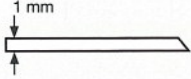
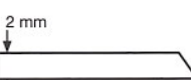
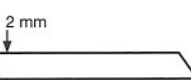
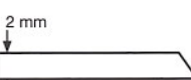
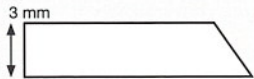
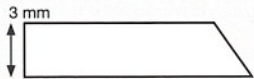
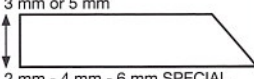
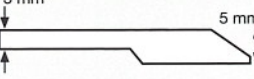

MATERIALE MATERIAL MATERIAL	SPESSORE - SEZIONE THICKNESS - SECTION ESPEJOR - SECCION	★★★ OTTIMO/EXCELLEN/EXCELENTE ★★★ MOLTO BUONO/VERY GOOD/MUY BIEN ★ BUONO/GOOD/BIEN	APPLICAZIONE APPLICATION APLICACION
<b>MR</b> METAL AND RUBBER		★★★	TRADITIONAL INKS
		★★	HYBRID INKS
		★	UV - H-UV - LED INKS
<b>MRE</b> METAL AND RUBBER  NBR + EPDM		★★★	TRADITIONAL INKS
		★★	HYBRID INKS
		★	UV - H-UV - LED INKS
<b>R</b> RUBBER		★★★	TRADITIONAL INKS
		★★	HYBRID INKS
		★	UV - H-UV - LED INKS
<b>P</b> PLASTIC		★★★	TRADITIONAL INKS
		★	UV - H-UV - LED INKS
		★★	HYBRID INKS
<b>SP</b> SPECIAL PLASTIC		★★	TRADITIONAL INKS
		★★★	HYBRID INKS
		★	UV - H-UV - LED INKS
<b>P</b> PLASTIC		★★	TRADITIONAL INKS
		★★★	HYBRID INKS
		★	UV - H-UV - LED INKS
<b>SP</b> SPECIAL PLASTIC		★★	TRADITIONAL INKS
		★★★	HYBRID INKS
		★	UV - H-UV - LED INKS
<b>P</b> PLASTIC		★★	UV - H-UV - LED INKS
		★★★	HYBRID INKS
		★	TRADITIONAL INKS
<b>SP</b> SPECIAL PLASTIC		★★	UV - H-UV - LED INKS
		★★★	HYBRID INKS
		★	TRADITIONAL INKS
<b>T</b> TEFLON (NORMAL)		★★★	UV - H-UV - LED INKS
		★★★	HYBRID INKS
		★★★	TRADITIONAL INKS
<b>ST</b> SHAPED TEFLON		★★★	UV - H-UV - LED INKS
		★★★	HYBRID INKS
		★★★	TRADITIONAL INKS
<b>V</b> VULCOLLAN		★★★	TRADITIONAL INKS
		★★★	HYBRID INKS
		★★★	UV - H-UV - LED INKS



**PIÙ DI 2000 DIVERSI TIPI  
DI RACLE DI LAVAGGIO!!  
MORE THAN 2000 DIFFERENT TYPES  
OF WASH-UP BLADES!!  
¡¡MAS DE 2000 TIPOS DIVERSOS  
DE REGLETAS DE LAVADO!!**



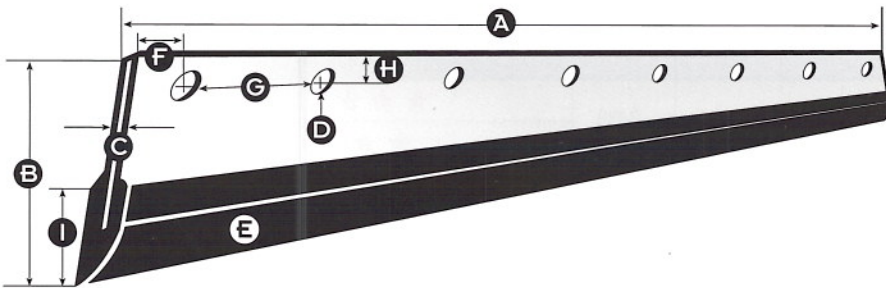







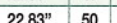

	CHIAVE DI LETTURA	KEY	LLAVE DE LECTURA
<b>A</b>	Lunghezza	Length	Longitud
<b>B</b>	Larghezza	Width	Ancho
<b>C</b>	Spessore	Thickness	Espesor
<b>D</b>	N° di fori	N° of holes	N° de agujeros
<b>E</b>	Materiale	Material	Material

**STANDARD = OFFICIAL WASH UP BLADE**  
 RACLE LAVARULLI PIÙ RICHIESTE  
 THE MOST POPULAR WASH-UP BLADES  
 REGLETAS LAVA-RODILLOS MAS SOLICITADAS

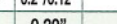
PER RACLE DI LAVAGGIO REALIZZATE IN MRE (PER INCHIOSTRI UV), VERRA' APPLICATO UN AUMENTO DI PREZZO DEL 15% SUL PREZZO DELLA RACLE REALIZZATA IN MR.  
 FOR WASH-UP BLADES MADE IN MRE (FOR UV INKS), WE WILL APPLY A 15% PRICE INCREASE ON THE PRICE OF THE BLADE IN MR.  
 PARA REGLETAS DE LAVADO REALIZADAS EN MRE (PARA TINTAS UV), SE APLICARA UN AUMENTO EN EL PRECIO DEL 15% SOBRE EL PRECIO DE LA REGLETA REALIZADA EN MR.

**KOMORI** \* RACLE DI LAVAGGIO PIU' VENDITE • MOST FREQUENTLY SOLD WASH-UP BLADES • REGLETAS DE LAVADO MAS VENDIDAS

CODICE CODE CODIGO	MACCHINA E MODELLO - MACHINE & MODEL - MÁQUINA Y MODELO	FORMATO SIZE FORMATO	A		B		C		D	E
			MM	INCHES	MM	INCHES	MM	INCHES		
895	KOMORI LITHRONE 20 - 420 (Flexible) (STANDARD)	36x52	580	22.83"	47	1.85"	0,5	0.02"	8	MR
895A	KOMORI LITHRONE 20 - 420 HERCULES BLADE 	36x52	580	22.83"	47	1.85"	5/3	0.2"/0.12"	8	ST
895B	KOMORI LITHRONE 20 - 420	36x52	580	22.83"	47	1.85"	5	0.20"	8	V
896	KOMORI LITHRONE 20 - 420	36x52	580	22.83"	50	1.97"	5	0.20"	8	SP
900	KOMORI SPRINT (Flexible)	36x52	590	23.23"	42	1.65"	0,5	0.02"	5	MR
905	KOMORI LITHRONE 20 - 420 (Rigid)	36x52	590	23.23"	35	1.38"	2	0.08"	5	MR
906	KOMORI LS 26	36x52	695	27.36"	47	1.85"	5	0.20"	10	V
906A	KOMORI LS 26 HERCULES BLADE 	36x52	965	27.36"	47	1.85"	5/3	0.2"/0.12"	10	ST
908	KOMORI LITHRONE 26 - A/W (Narrow)	46x65	700	27.56"	42	1.65"	0,5	0.02"	10	MR
907	KOMORI LITHRONE SPRINT 26/226-VARIANT (Flexible)	46x65	706	27.80"	47	1.85"	0,5	0.02"	10	MR
907A	KOMORI LITHRONE SPRINT 26/226-VARIANT (Flexible) Fori ovali-oval holes-agujeros ovales	46x65	706	27.80"	47	1.85"	0,5	0.02"	10	MR
910	KOMORI SPRINT L 25 (Flexible)	46x65	710	27.95"	42	1.65"	0,5	0.02"	6	MR
911	KOMORI SPRINT 25	46x65	710	27.95"	35	1.38"	5	0.20"	12	V
915	KOMORI SPRINT 26 (Rigid)	46x65	715	28.15"	50	1.97"	2	0.08"	6	MR
918	KOMORI SPICA 26	48x66	715	28.15"	37	1.46"	1	0.04"	10	SP
919	KOMORI SPICA 26	48x66	715	28.15"	37	1.46"	0,5	0.02"	10	MR
936	KOMORI LITHRONE 26 (Blanket autowash)	48x66	715	28.15"	42	1.65"	0,5	0.02"	10	MR
920	KOMORI SPRINT 25 NEW TYPE (Flexible)	46x65	719	28.31"	45	1.77"	0,5	0.02"	6	MR
922	KOMORI SPRINT 26	46x65	720	28.35"	43	1.62"	0,5	0.02"	8	MR
915A	KOMORI SPRINT 26 VARIANT	46x65	720	28.35"	50	1.97"	0,5	0.02"	8	MR
921	KOMORI SPRINT (Flexible)	46x65	725	28.54"	50	1.97"	0,5	0.02"	0	MR
925	KOMORI LITHRONE 26 SPRINT (Rigid) (STANDARD)	48x66	726	28.58"	35	1.38"	2	0.08"	6	MR
930	KOMORI LITHRONE 26 (Flexible) (STANDARD)	48x66	726	28.58"	37	1.46"	0,5	0.02"	6	MR
935	KOMORI LITHRONE 26 - 526 (Flexible)	48x66	726	28.58"	42	1.65"	0,5	0.02"	6	MR
923	KOMORI LITHRONE S 26	48x66	730	28.74"	35	1.38"	1	0.04"	10	SP
924	KOMORI LITHRONE S 26	48x66	730	28.74"	35	1.38"	0,5	0.02"	10	MR
937	KOMORI LITHRONE 26 - 426	48x66	730	28.74"	35	1.38"	1	0.04"	10	SP
955	KOMORI LITHRONE 428	52x72	765	30.12"	47	1.85"	5	0.20"	11	SP
955A	KOMORI LITHRONE 428	52x72	765	30.12"	47	1.85"	5	0.20"	11	V
960	KOMORI LITHRONE 28-528 - KOMORI SPRINT 28 II (Flexible) (STANDARD)	52x72	765	30.12"	47	1.85"	0,5	0.02"	11	MR
962	KOMORI LITHRONE 528 (Flexible) (STANDARD)	52x72	775	30.51"	47	1.85"	0,5	0.02"	11	MR
962A	KOMORI LITHRONE 528 HERCULES BLADE 	52x72	775	30.51"	47	1.85"	5/3	0.2"/0.12"	11	ST
962B	KOMORI LITHRONE 528	52x72	775	30.51"	47	1.85"	5	0.20"	11	V
940	KOMORI LITHRONE 28 SPRINT (Rigid) (STANDARD)	52x72	785	30.91"	35	1.38"	2	0.08"	6	MR
945	KOMORI LITHRONE 28 SPRINT (Flexible)	52x72	785	30.91"	37	1.46"	0,5	0.02"	6	MR
946	KOMORI LITHRONE 28 - 428 - 528	52x27	785	30.91"	37	1.46"	5	0.20"	6	SP
950	KOMORI LITHRONE 28 (Flexible)	52x72	780	30.71"	42	1.65"	0,5	0.02"	9	MR
950A	KOMORI LITHRONE 28 HERCULES BLADE 	52x72	780	30.71"	42	1.65"	5/3	0.2"/0.12"	9	ST
961A	KOMORI SPICA 29	53x75	805	31.69"	38	1.50"	1	0.04"	11	SP
961	KOMORI SPICA 29 (STANDARD)	53x75	805	31.70"	48	1.89"	0,5	0.02"	11	MR
963	KOMORI SPICA 29 SPECIAL PLASTIC	53x75	808	31.81"	38	1.50"	2	0.08"	11	SP
963A	KOMORI SPICA 29	53x75	809	31.85"	38	1.50"	0,5	0.02"	11	MR
963B	KOMORI SPICA 29 HERCULES BLADE 	53x75	809	31.85"	38	1.50"	5/3	0.2"/0.12"	11	ST
963C	KOMORI SPICA 29	53x75	809	31.85"	38	1.50"	3	0.12"	11	V
966	KOMORI LSX 29 - 429 - 529 - 629 - 829 (STANDARD)	61x75	820	32.28"	35	1.38"	1	0.04"	11	SP
966A	KOMORI L29 - 429 - 529 - 629 - 829	53x75	820	32.28"	36	1.42"	0,5	0.02"	11	MR
966D	KOMORI LS 29 H-UV	53x75	820	32.28"	36	1.42"	3	0.12"	11	V
966D1	KOMORI LS 29 H-UV	53x75	820	32.28"	36	1.42"	5	0.20"	11	V
966E	KOMORI LS 29 H-UV	53x75	820	32.28"	36	1.42"	3	0.12"	11	T
966J	KOMORI LS 29 HERCULES BLADE 	53x75	820	32.28"	36	1.42"	5/3	0.2"/0.12"	11	ST
966B	KOMORI LSX - SPICA 29 - 429 - 529 - 629 - 829 HERCULES BLADE 	53x75	825	32.48"	36	1.42"	5/3	0.2"/0.12"	11	ST
966C	KOMORI LSX - SPICA 29	53x75	825	32.48"	36	1.42"	3	0.12"	11	V
966F	KOMORI LITHRONE S 32 / 532	61x82	950	37.40"	47	1.85"	0,5	0.02"	13	MR
966L	KOMORI LITHRONE A37 - A37 P	61x82	1010	39.76"	35	1.38"	3	0.12"	13	V
966M	KOMORI LITHRONE A37 HERCULES BLADE 	61x82	1010	39.76"	35	1.38"	5/3	0.2"/0.12"	13	ST



**UNIVERSAL BLADE for  
KOMORI LITHRONE 40 - GX/G SERIES - SX/S SERIES**  
MATERIAL: SPECIAL PLASTIC - THICKNESS: 1mm - N. 15 HOLES

CODE 1009 L

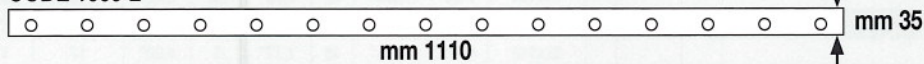

CODE 1009 M

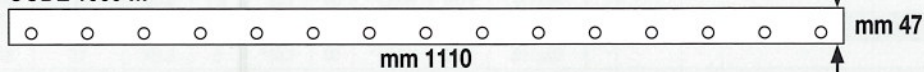



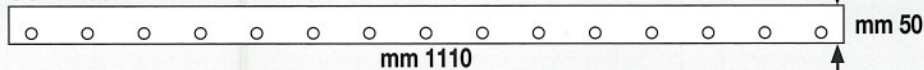

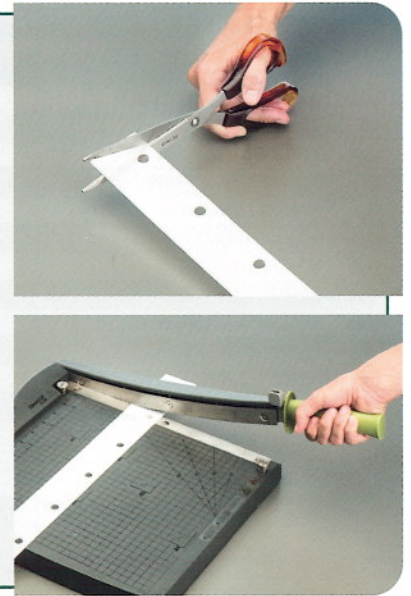

CODE 1009 N

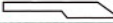

Taglio e messa a misura a seconda della lunghezza necessaria per la vostra macchina  
Cutting-to-size according to the length your machine requires  
Corte y puesta a medida de acuerdo con la longitud necesaria para su máquina

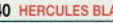

CODICE CODE CODIGO	MACCHINA E MODELLO - MACHINE & MODEL - MÁQUINA Y MODELO	FORMATO SIZE FORMATO	A		B		C		D	E
			MM	INCHES	MM	INCHES	MM	INCHES		
966G	KOMORI LITHRONE G 37	64x94	1014	39.92"	35	1.38"	1	0.04"	13	SP
966H	KOMORI LITHRONE G 37	72x103	1014	39.92"	35	1.38"	3	0.12"	13	V
966K	KOMORI LITHRONE L 37 <b>HERCULES BLADE</b> 	72x103	1014	39.92"	35	1.38"	5/3	0.2"/0.12"	13	ST
1009A	KOMORI LITHRONE S 440 - 540 - 640 - 840	72x103	1045	41.14"	50	1.97"	1	0.04"	14	SP
1009D	KOMORI LITHRONE SX 40	72x103	1045	41.14"	50	1.97"	0,5	0.02"	14	MR
1012A	KOMORI LSX 40 - 440 - 540 - 640 - 840	72x103	1065	41.93"	50	1.97"	1	0.04"	14	SP
975	KOMORI LITHRONE 40	72x103	1067	42.01"	47	1.85"	5	0.20"	15	SP
980	KOMORI LITHRONE 40	72x103	1067	42.01"	47	1.85"	0,5	0.02"	15	MR
995	KOMORI LITHRONE 40	72x103	1076	42.36"	47	1.85"	0,5	0.02"	15	MR
1000	KOMORI LITHRONE 40	72x103	1076	42.36"	47	1.85"	5	0.20"	15	SP
1001	KOMORI LITHRONE 40	72x103	1076	42.36"	42	1.65"	5	0.20"	15	SP
1002	KOMORI LITHRONE 40 A/W	72x103	1076	42.36"	50	1.97"	5	0.20"	8	SP
982	KOMORI LITHRONE 40 - 440 - 540 - 640 - 840 (Blanket autowash)	72x103	1080	42.52"	53	2.09"	0,5	0.02"	12	MR
982A	KOMORI LITHRONE 40 EPDM FOR UV	72x103	1080	42.52"	50	1.97"	0,5	0.02"	12	MRE
1009R	KOMORI LITHRONE GX 40 <b>HERCULES BLADE</b> 	72x103	1085	42.72"	50	1.97"	5/3	0.2"/0.12"	15	ST
1009G	KOMORI LITHRONE GX 40	72x103	1085	42.72"	50	1.97"	1	0.04"	15	SP
1009P	KOMORI LITHRONE GX 40	72x103	1085	42.72"	50	1.97"	5	0.20"	15	V
1009S	KOMORI LITHRONE GX 40	72x103	1117	43.98"	50	1.97"	1	0.04"	15	SP
965A	KOMORI LITHRONE 40	72x103	1090	42.91"	50	1.97"	5	0.20"	8	SP
965B	KOMORI LITHRONE 40	72x103	1090	42.91"	50	1.97"	5	0.20"	8	V
985	KOMORI LITHRONE 40 (STANDARD)	72x103	1090	42.91"	47	1.85"	0,5	0.02"	15	MR
990	KOMORI LITHRONE 40 (Fori ovali - oval holes - agujeros ovales)	72x103	1090	42.91"	47	1.85"	0,5	0.02"	15	MR
964	KOMORI LITHRONE 40	72x103	1095	43.11"	52	2.05"	0,5	0.02"	8	MR
965	KOMORI LITHRONE 40	72x103	1095	43.11"	50	1.97"	5	0.20"	8	SP
967	KOMORI LITHRONE 40	72x103	1095	43.11"	50	1.97"	5	0.20"	15	SP
967A	KOMORI LITHRONE 40	72x103	1095	43.11"	50	1.97"	5	0.20"	15	V
968	KOMORI LITHRONE 40	72x103	1095	43.11"	50	1.97"	0,5	0.02"	15	MR
970	KOMORI LITHRONE 40	72x103	1095	43.11"	50	1.97"	0,5	0.02"	8	MR
970A	KOMORI LITHRONE 40	72x103	1098	43.23"	47	1.85"	1	0.04"	15	SP
1009C	KOMORI LITHRONE G40 - KOMORI GL 40-440	72x103	1098	43.23"	50	1.97"	1	0.04"	15	SP
1009E	KOMORI LITHRONE G 40 - 440 <b>HERCULES BLADE</b> 	72x103	1098	43.23"	50	1.97"	5/3	0.2"/0.12"	15	ST
1010	KOMORI LITHRONE 40	72x103	1098	43.23"	52	2.05"	5	0.20"	15	V
1010A	KOMORI LITHRONE 40 (SPECIAL)	72x103	1098	43.23"	52	2.05"	5	0.20"	15	V
1015	KOMORI LITHRONE 40	72x103	1098	43.23"	52	2.05"	0,5	0.02"	15	MR
1017	KOMORI LITHRONE 40	72x103	1098	43.23"	52	2.05"	5	0.20"	15	SP
1017A	KOMORI LITHRONE S 40 SP	72x104	1100	43.30"	35	1.38"	1	0.04"	15	SP
1009	KOMORI LITHRONE S 440 - 540 - 640 - 840 (STANDARD)	72x104	1105	43.50"	50	1.97"	1	0.04"	15	SP
1011	KOMORI LITHRONE S 440 - 540 - 640 - 840 (STANDARD)	72x104	1105	43.50"	50	1.97"	0,5	0.02"	15	MR
1011A	KOMORI LITHRONE S 440 - 540 - 640 - 840 <b>HERCULES BLADE</b> 	72x104	1105	43.50"	50	1.97"	5/3	0.2"/0.12"	15	ST
1011B	KOMORI LITHRONE S 440 - 540 - 640 - 840	72x104	1105	43.50"	50	1.97"	5	0.20"	15	V
1011C	KOMORI LITHRONE S 440 - 540 - 640 - 840	72x104	1105	43.50"	50	1.97"	3	0.12"	15	V
1012	KOMORI LSX 40 - 440 - 540 - 640 - 840	72x104	1105	43.50"	50	1.97"	1	0.04"	14	SP
1005	KOMORI LITHRONE 40 (STANDARD)	72x103	1110	43.70"	47	1.85"	0,5	0.02"	15	MR
1005A	KOMORI LITHRONE 40 - 440 - 540 - 640 - 840 <b>HERCULES BLADE</b> 	72x103	1110	43.70"	47	1.85"	5/3	0.2"/0.12"	15	ST
1007	KOMORI LITHRONE 40	72x103	1110	43.70"	47	1.85"	5	0.20"	15	SP
1008	KOMORI LITHRONE S40 2003 (STANDARD)	72x103	1110	43.70"	47	1.85"	1	0.04"	15	SP
1008A	KOMORI LITHRONE S 40	72x104	1110	43.70"	47	1.85"	2	0.08"	15	SP
1008B	KOMORI LITHRONE 40 - 440 - 540 - 640 - 840	72x103	1110	43.70"	47	1.85"	5	0.20"	15	V
1009B	KOMORI LITHRONE S 440 - 450 - 640 - 840 <b>HERCULES BLADE</b> 	72x103	1110	43.70"	50	1.97"	5/3	0.2"/0.12"	15	ST
1009F	KOMORI LITHRONE G 40 P									



CODICE CODE CODIGO	MACCHINA E MODELLO - MACHINE & MODEL - MÁQUINA Y MODELO	FORMATO SIZE FORMATO	A		B		C		D	E
			MM	INCHES	MM	INCHES	MM	INCHES		
1009H	KOMORI LITHRONE GX 40 P									
1009K	KOMORI LITHRONE G 44									
1018	KOMORI LITHRONE 44	74x104	1120	44.09"	52	2.05"	0,5	0.02"	15	MR
1018A	KOMORI LITHRONE 640	74x104	1120	44.09"	47	1.85"	5	0.20"	15	V
1019	KOMORI LITHRONE 44	82x113	1185	45.65"	45	1.77"	5	0.20"	17	V
1019A	KOMORI LITHRONE 44	82x113	1188	46.77"	46	1.81"	5	0.20"	17	V
1023	KOMORI LITHRONE 44	82x113	1190	46.89"	50	1.97"	0,5	0.02"	9	MR
1020	KOMORI LITHRONE 44	82x113	1192	46.93"	50	1.97"	0,5	0.02"	17	MR
1021	KOMORI LITHRONE 44	82x113	1192	46.93"	50	1.97"	5	0.20"	17	SP
1019B	KOMORI LITHRONE 44	82x113	1193	46.97"	50	1.97"	5	0.20"	17	V
1022	KOMORI LITHRONE 44 SP	82x113	1210	47.64"	47	1.85"	0,5	0.02"	17	MR

## KOMORI

CODICE CODE CODIGO	MACCHINA E MODELLO - MACHINE & MODEL - MÁQUINA Y MODELO	FORMATO SIZE FORMATO	A		B		C		D	E
			MM	INCHES	MM	INCHES	MM	INCHES		
1024	KOMORI LITHRONE 44	82x113	1210	47.64"	47	1.85"	5	0.20"	17	SP
1035	KOMORI LITHRONE 50	96,5x128	1376	54.17"	50	1.97"	5	0.20"	19	SP
1040	KOMORI LITHRONE 50	96,5x128	1380	54.33"	50	1.97"	0,5	0.02"	10	MR
1025	KOMORI LITHRONE 50	96,5x128	1380	54.33"	50	1.97"	5	0.20"	10	SP
1030	KOMORI LITHRONE 50	96,5x128	1380	54.33"	42	1.65"	0,5	0.02"	19	MR
1043	KOMORI LITHRONE 50	96,5x128	1380	54.33"	50	1.97"	0,5	0.02"	19	MR
1042	KOMORI LITHRONE 50	96,5x128	1385	54.53"	50	1.97"	3	0.12"	19	SP

## KOMORI CHAMBON (SERIES)

CODICE CODE CODIGO	MACCHINA E MODELLO - MACHINE & MODEL - MÁQUINA Y MODELO	FORMATO SIZE FORMATO	A		B		C		D	E
			MM	INCHES	MM	INCHES	MM	INCHES		
3455	KOMORI CHAMBON		657	25.87"	46	1.81"	1	0.04"	7	P
916	KOMORI CHAMBON		725	28.54"	40	1.57"	1	0.04"	0	SP
917	KOMORI CHAMBON		725	28.54"	40	1.57"	0,5	0.02"	0	MR
3456	KOMORI CHAMBON		734	28.90"	30	1.19"	1	0.04"	0	P
3457	KOMORI CHAMBON		792	31.18"	40	1.57"	1	0.04"	0	P
3458	KOMORI CHAMBON		792	31.18"	40	1.57"	0,5	0.02"	0	MR

## KOMORI BANKNOTE (SERIES)

CODICE CODE CODIGO	MACCHINA E MODELLO - MACHINE & MODEL - MÁQUINA Y MODELO	FORMATO SIZE FORMATO	A		B		C		D	E
			MM	INCHES	MM	INCHES	MM	INCHES		

## KOMORI WEB

CODICE CODE CODIGO	MACCHINA E MODELLO - MACHINE & MODEL - MÁQUINA Y MODELO	FORMATO SIZE FORMATO	A		B		C		D	E
			MM	INCHES	MM	INCHES	MM	INCHES		
1041	KOMORI SYSTEM 18 S									
1050	KOMORI SYSTEM 20	WEB OFFSET	590	23.33"	56	2.20"	0,5	0.02"	7	MR
1050A	KOMORI SYSTEM 25									
1060	KOMORI SYSTEM 35	WEB OFFSET	960	37.80"	49	1.95"	0,5	0.02"	13	MR
1061	KOMORI SYSTEM 35	WEB OFFSET	960	37.80"	49	1.95"	1	0.04"	13	SP
1065	KOMORI SYSTEM 35 B2	WEB OFFSET	970	38.19"	50	1.97"	0,5	0.02"	13	MR
1065A	KOMORI SYSTEM 35	WEB OFFSET	970	38.19"	47	1.85"	0,5	0.02"	13	MR
1066	KOMORI SYSTEM 35 WL /UPPER	WEB OFFSET	970	38.19"	55	2.17"	0,5	0.02"	11	MR
1067	KOMORI SYSTEM 35 WL /UPPER	WEB OFFSET	970	38.19"	55	2.17"	1	0.04"	11	SP
1068	KOMORI SYSTEM 35 WL /LOWER	WEB OFFSET	970	38.19"	63	2.48"	0,5	0.02"	11	MR
1069	KOMORI SYSTEM 35 WL /LOWER	WEB OFFSET	970	38.19"	63	2.48"	1	0.04"	11	SP
1070	KOMORI SYSTEM 38	WEB OFFSET	1029	40.51"	47	1.85"	0,5	0.02"	11	MR
1055	KOMORI SYSTEM 40	WEB OFFSET	1030	40.55"	47	1.85"	0,5	0.02"	11	MR
1071	KOMORI SYSTEM 38	WEB OFFSET	1040	40.94"	55	2.17"	0,5	0.02"	11	MR
1071A	KOMORI SYSTEM 38	WEB OFFSET	1040	40.94"	55	2.17"	5	0.20"	0	V
1072	KOMORI SYSTEM 38	WEB OFFSET	1050	41.34"	50	1.97"	0,5	0.02"	11	MR
1073	KOMORI SYSTEM 38 D	WEB OFFSET	1060	41.73"	48	1.89"	0,5	0.02"	15	MR
1074	KOMORI SYSTEM G 38									
1075	KOMORI SYSTEM 40									
1076	KOMORI SYSTEM 43									



## REALIZZAZIONE RACLE SPECIALI O PERSONALIZZATE

Qualsiasi racla non elencata nel presente catalogo potrà essere realizzata su specifica richiesta per un quantitativo minimo da convenire. Compilate questa scheda con tutti i dati ed inviatela per e-mail a: [pavan@pavanvr.com](mailto:pavan@pavanvr.com)

## MANUFACTURE OF SPECIAL OR PERSONALISED WASH-UP BLADES

Any blade not indicated in this catalogue can be made on specific request; the minimum order quantity is to be agreed. Please complete the form below with all the details and send it by e-mail to: [pavan@pavanvr.com](mailto:pavan@pavanvr.com)

## FABRICACION REGLETAS ESPECIALES O PERSONALIZADAS

Cualquier racla que no figure en el presente catálogo se podrá realizar, bajo pedido especial, por una cantidad mínima a convenir. Rellenar esta ficha con todos los datos y enviarla por e-mail a [pavan@pavanvr.com](mailto:pavan@pavanvr.com)

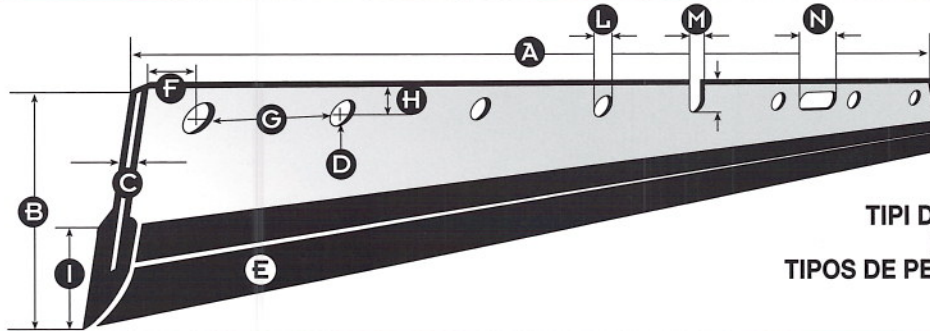

TIPI DI FORATURA  
HOLE TYPES  
TIPOS DE PERFORACION

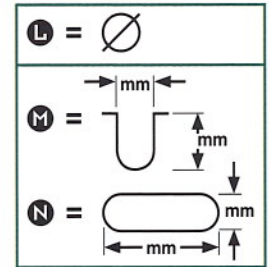

NOME DELLA MACCHINA E MODELLO		MACHINE NAME AND MODEL		NOMBRE DE LA MAQUINA Y MODELO		
N.B.: Per la buona riuscita dell'articolo si prega la gentile clientela di indicare esattamente le misure richieste in mm.		N.B.: Please indicate the exact measurements in mm./inches to ensure the perfect reproduction of the blade		N.B.: Para una perfecta producción del artículo, se ruega a la gentil clientela de indicar exactamente las medidas solicitadas en mm.		
LEGENDA	mm	KEY	mm	inch.	LLAVE DE LECTURA	mm
A = Lunghezza racla		A = Length of blade			A = Longitud regleta	
B = Larghezza complessiva		B = Overall width			B = Ancho total	
C = Spessore		C = Thickness			C = Espesor	
D = Numero fori o asole		D = No. of holes or slots			D = N. de agujeros o muescas	
E = Materiale		E = Material			E = Material	
MR = Metallo + gomma	<input type="checkbox"/>	MR = Metal + rubber		<input type="checkbox"/>	MR = Metal + goma	<input type="checkbox"/>
MRE = Metallo + gomma EPDM	<input type="checkbox"/>	MRE = Metal + rubber "EPDM"		<input type="checkbox"/>	MRE = Metal + goma "EPDM"	<input type="checkbox"/>
P = Plastica	<input type="checkbox"/>	P = Plastic		<input type="checkbox"/>	P = Plástico	<input type="checkbox"/>
SP = Plastica speciale	<input type="checkbox"/>	SP = Special plastic		<input type="checkbox"/>	SP = Plástico especial	<input type="checkbox"/>
R = Gomma	<input type="checkbox"/>	R = Rubber		<input type="checkbox"/>	R = Goma	<input type="checkbox"/>
V = Vulcollan	<input type="checkbox"/>	V = Vulcollan		<input type="checkbox"/>	V = Vulcollan	<input type="checkbox"/>
T = Teflon	<input type="checkbox"/>	T = Teflon		<input type="checkbox"/>	T = Teflón	<input type="checkbox"/>
ST = Teflon sagomato	<input type="checkbox"/>	ST = Shaped teflon		<input type="checkbox"/>	ST = Teflon moldeado	<input type="checkbox"/>
PVC	<input type="checkbox"/>	PVC		<input type="checkbox"/>	PVC	<input type="checkbox"/>
FA = Fibra laminato + alluminio	<input type="checkbox"/>	FA = Laminated fibre + aluminium		<input type="checkbox"/>	FA = Fibra laminada + aluminio	<input type="checkbox"/>
RA = Gomma + alluminio	<input type="checkbox"/>	RA = Rubber + aluminium		<input type="checkbox"/>	RA = Goma + aluminio	<input type="checkbox"/>
MRA = Metallo + Gomma accoppiata	<input type="checkbox"/>	MRA = Metal + Rubber coupled		<input type="checkbox"/>	MRA = Metal + Goma acopiados	<input type="checkbox"/>
F = Fibra laminata	<input type="checkbox"/>	F = Laminated fibre		<input type="checkbox"/>	F = Fibra laminada	<input type="checkbox"/>
F = Distanza dallo spigolo al centro del primo foro		F = Distance from blade end to centre of first hole			F = Distancia del extremo al centro del primer agujero	
G = Distanza dei fori (da centro a centro)		G = Hole spacing (centre to centre)			G = Distancia entre los agujeros (del centro al centro)	
H = Distanza dal lato della racla al centro del foro		H = Distance from blade edge to centre of hole			H = Distancia del borde al centro del agujero	
I = Altezza profilo in gomma		I = Rubber profile width			I = Ancho del perfil de goma	
L = Diametro foro		L = Diametre of hole			L = Diámetro del agujero	
M = Dimensioni asola		M = Sizes of slot			M = Dimensiones del las muescas	
N = Dimensioni foro ovale		N = Sizes of oval hole			N = Dimensiones del agujero ovalado	
"STANDARD" = Profilo in gomma "NBR" con durezza "STANDARD" a 95 shore (dura)	<input type="checkbox"/>	"STANDARD" = Rubber profile "NBR" with 95 "STANDARD" shore (hard)		<input type="checkbox"/>	"ESTANDAR" = Perfil de goma "NBR" con durezza "ESTANDAR" 95 shore (dura)	<input type="checkbox"/>
"SOFT" = Profilo in gomma "NBR" con durezza "SPECIALE" a 85 shore (morbida)	<input type="checkbox"/>	"SOFT" = Rubber profile "NBR" with 85 "SPECIAL" shore (soft)		<input type="checkbox"/>	"SOFT" = Perfil de goma "NBR" con durezza "ESPECIAL" 85 shore (blanda)	<input type="checkbox"/>
"UV" = Profilo in gomma "EPDM" con durezza 85 shore in presenza di macchine da stampa che utilizzano inchiostri "UV"	<input type="checkbox"/>	"UV" = Rubber profile "EPDM" with 85 shore for "UV" ink printing machines		<input type="checkbox"/>	"UV" = Perfil de goma "EPDM" con durezza 85 shore para máquinas que usan tintas "UV"	<input type="checkbox"/>
<b>IMPORTANTE:</b> Su specifica richiesta tutte le raclе lavaruili da noi prodotte possono essere fornite con lo speciale profilo in gomma "EPDM" avente durezza 85 shore necessario nei casi si presentino macchine da stampa che utilizzano inchiostri "UV"		<b>IMPORTANT:</b> On specific request, all the blades we manufacture can be supplied with special "EPDM" rubber profile with 85 shore, required for "UV" ink printing		<b>IMPORTANTE:</b> Bajo pedido especial, todas las regletas fabricadas por nosotros se pueden suministrar con el perfil en goma "EPDM" con durezza 85 shore, necesario para todas las máquinas que trabajan con tintas "UV"		





**KOMORI**

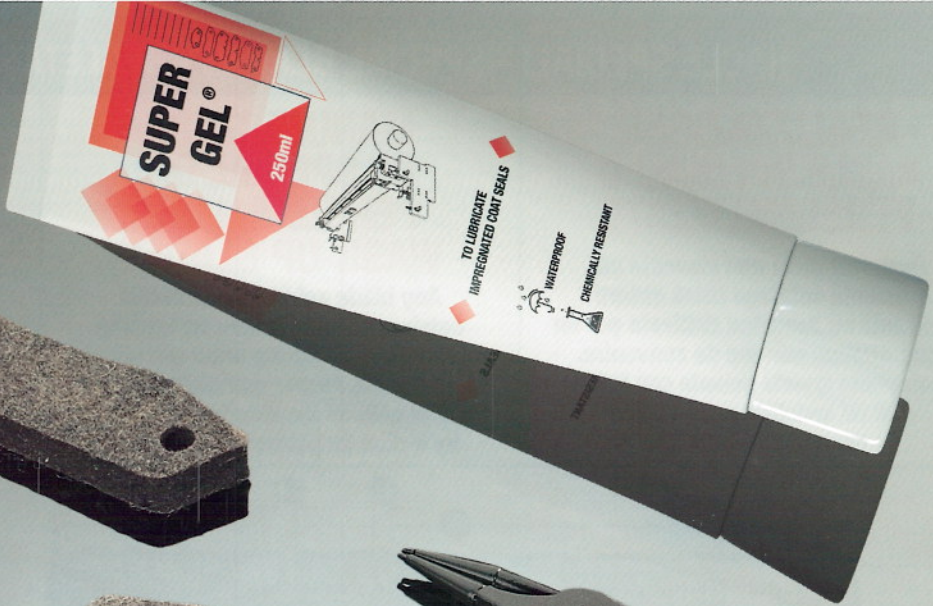

# SUPER COAT SEALS®

GUARNIZIONI LATERALI PER IMPIANTI DI VERNICIATURA  
LATERAL COAT SEALS FOR COATING UNITS  
GUARNICIONES LATERALES PARA INSTALACIONES DE BARNIZADO

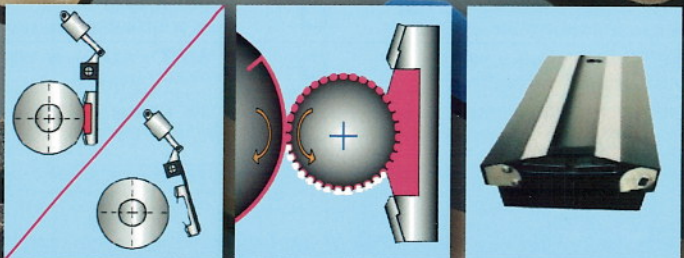



# ALL-IN-ONE SUPER COAT SEALS

## UNIVERSAL COAT SEALS FOR ALL TRESU D2 CHAMBERS

EPDM RUBBER FOR ALL APPLICATIONS: FOR WATER-BASED AND "UV" VARNISHING

MATERIALS AVAILABLE: FELT / FOAM / Rubber / Silicone

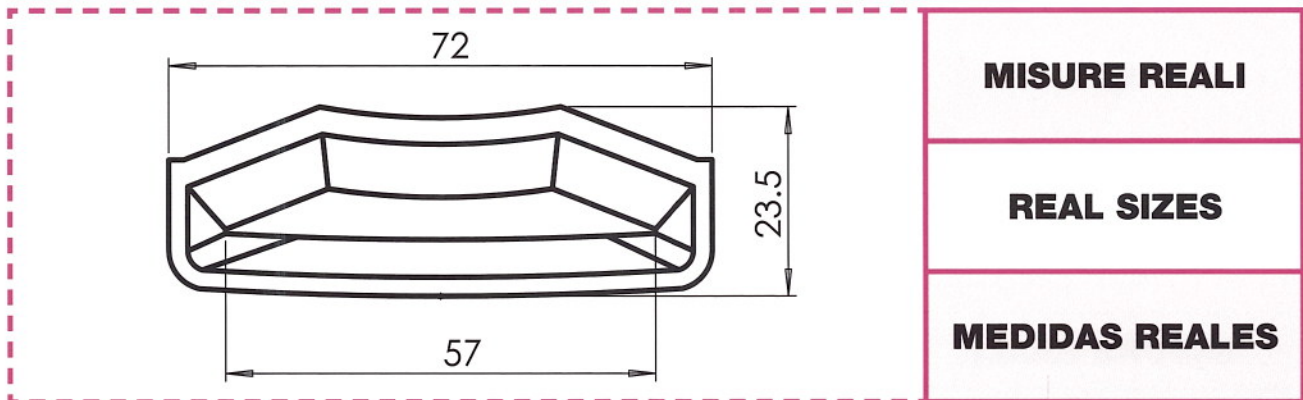

Impregnated FELT code 18650-A



Rubber code 18650



SILICONE code 18650-C

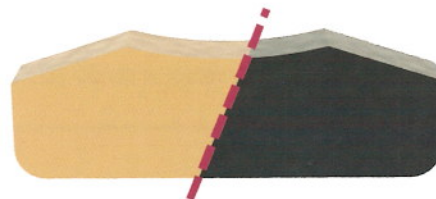

FOAM code 18650-B Beige  
FOAM code 18650-D Black

confezione da 50 pz / packet of 50 pcs / confeccion de 50 pz

## BLOCKING CLIPS - MOLLE DI BLOCCAGGIO

CODE	DESCRIPTION
18651	BLOCKING CLIP D1 - D2 SMALL

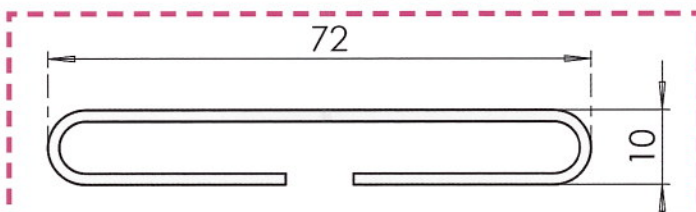

MISURE REALI | REAL SIZES | MEDIDAS REALES

CODE	DESCRIPTION
18684	PINCER FOR SUPER COAT SEAL

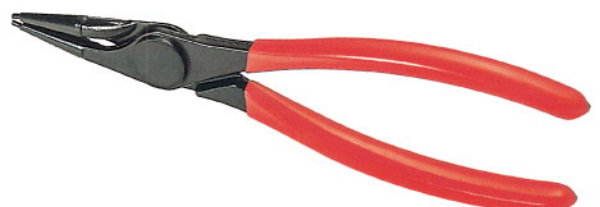



MODEL **KOMORI LS29**

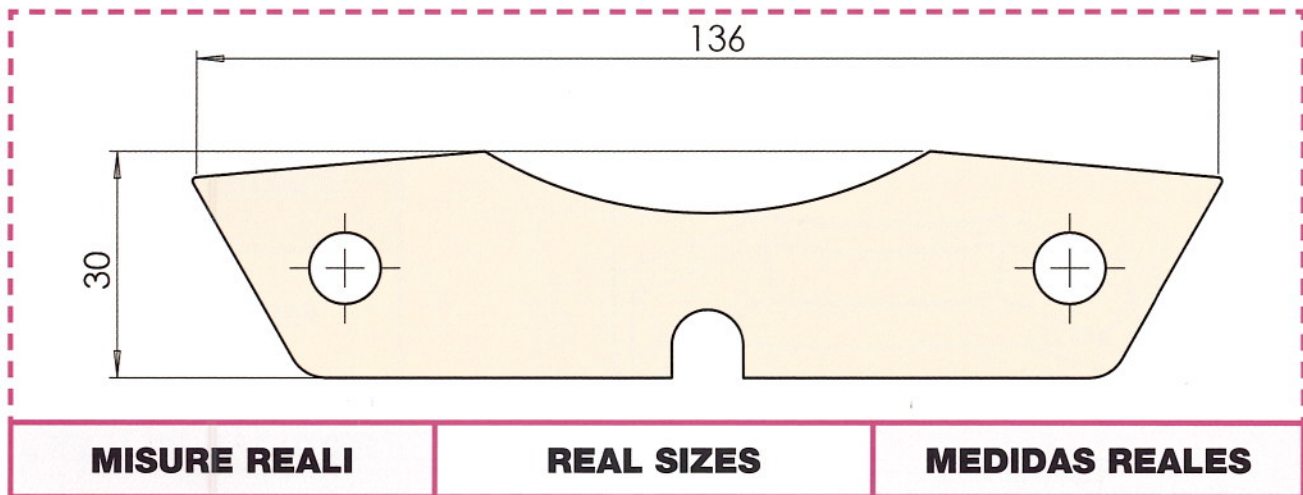

**Impregnated FELT code 18688**

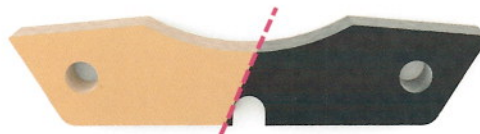

**FOAM code 18823 Beige**  
**FOAM code 18823-A Black**

*confezione da 50 pz / packet of 50 pcs / confeccion de 50 pz*

MODEL **KOMORI LS29**

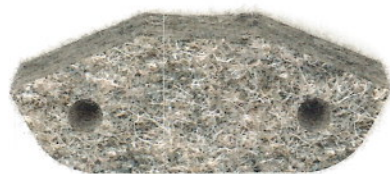
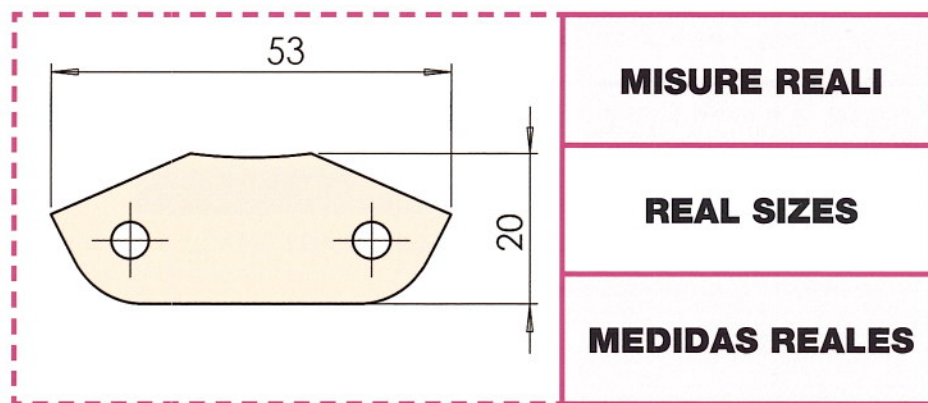

**Impregnated FELT code 18687**

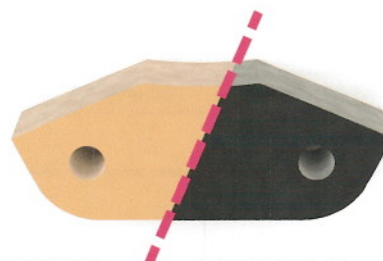

**FOAM code 18836 Beige**  
**FOAM code 18836-A Black**

*confezione da 50 pz / packet of 50 pcs / confeccion de 50 pz*



MODEL	<b>KOMORI GL 40</b>
-------	---------------------

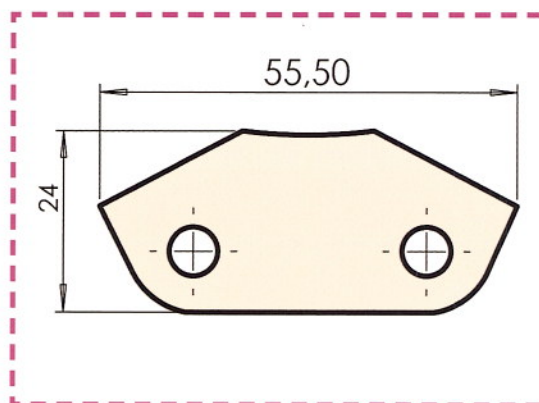

**MISURE REALI**

**REAL SIZES**

**MEDIDAS REALES**

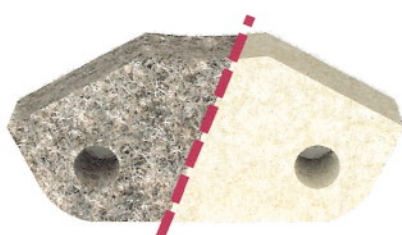

Impregnated FELT code 18680 Grey  
Impregnated FELT code 18680A White

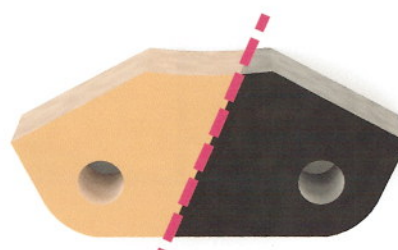

FOAM code 18681 Beige  
FOAM code 18817-A Black

*confezione da 50 pz / packet of 50 pcs / confeccion de 50 pz*

**NEW**

# SUPER GEL®



CODE	DESCRIPTION
18686	SUPER GEL® (tube of 250 ml)

**UNIVERSAL LUBRICATION FOR IMPREGNATED COAT SEALS - 250ML TUBE.**  
**LUBRIFICANTE UNIVERSALE PER COAT SEALS - TUBETTO DA 250ML.**  
**LUBRICANTE UNIVERSAL PARA COAT SEALS - TUBO 250ML.**

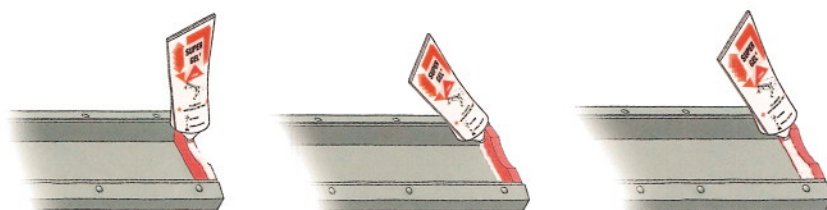

**Correct lubrication of Coat Seals**





# ROYAL CUTTER

FOR DOCTOR BLADES

The new Royal Cutter for Doctor Blades allows you to cut to any size in total freedom. Furthermore, to make it easier for you, we have created three versions with variable maximum extension.

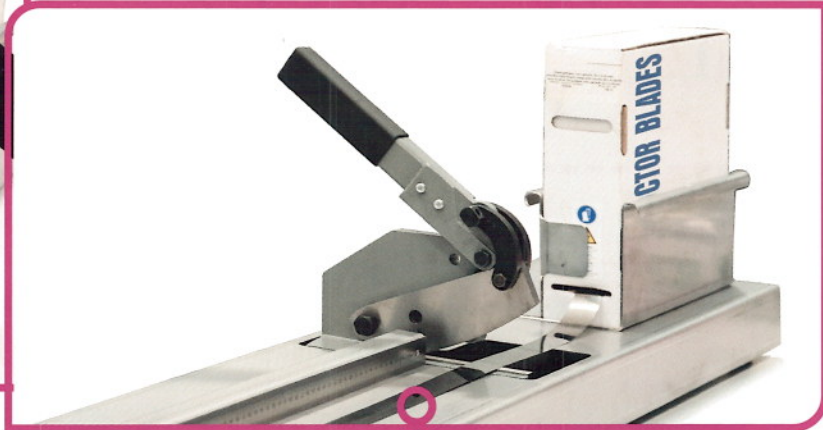

**NEW**

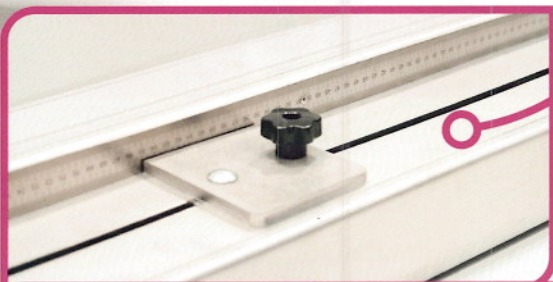
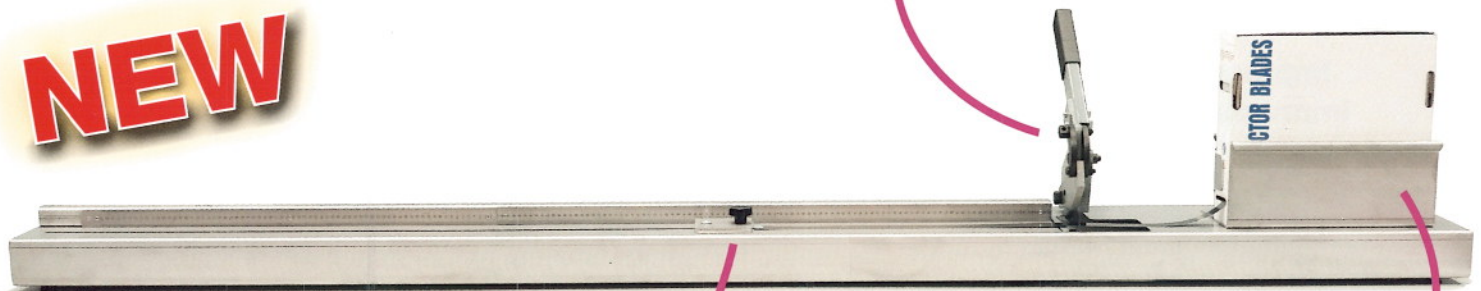

**THE WIDTH AND THE HEIGHT CAN BE REGULATED !!**



CODE	DESCRIPTION - SIZE
18740	ROYAL CUTTER SIZE 1300mm
18741	ROYAL CUTTER SIZE 1500mm
18742	ROYAL CUTTER SIZE 1700mm





# SUPER DOCTOR BLADES

IN ACCIAIO - IN STEEL - EN ACERO

PER VERNICI ACRILICHE A BASE DI ACQUA E VERNICI "UV"  
FOR ACRYLIC WATER BASED AND "UV" COATINGS  
PARA BARNICES ACRILICOS BASE AGUA Y BARNICES "UV"

UNIVERSAL  
PRODUCT

IN ROTOLO - IN ROLLS - EN ROLLOS

CODICE CODE CODIGO	MODELLO MACCHINA MACHINE MODEL MODELO DE MAQUINA	ALTEZZA / SPESSORE IN MM WIDTH / THICKNESS IN MM ANCHO / ESPESOR IN MM	FORNITO IN ROTOLO SUPPLIED IN ROLLS SUMINISTRADO EN ROLLOS	GRUPPO DI VERNICIATURA VARNISHING GROUP GRUPO DE BARNIZADO
18501-A	KOMORI	25 MM X 0,20 MM	ROLL OF 100 MT.	HARRIS & BRUNO
18502-A	KOMORI	28 MM X 0,20 MM	ROLL OF 100 MT.	HARRIS & BRUNO
18503-A	KOMORI LITHRONE G 40	32 MM X 0,20 MM	ROLL OF 100 MT.	HARRIS & BRUNO
18504-A	KOMORI	35 MM X 0,20 MM	ROLL OF 100 MT.	TRESU

IN LUNGHEZZE PRE-TAGLIATE - IN PRE-CUT LENGTHS - EN LONGITUD PRECORTADAS  
PER GRUPPO "HARRIS & BRUNO" - FOR "HARRIS & BRUNO" CHAMBERS - PARA GRUPO "HARRIS & BRUNO"

CODICE CODE CODIGO	MODELLO MACCHINA MACHINE MODEL MODELO DE MAQUINA	ALTEZZA / SPESSORE IN MM WIDTH / THICKNESS IN MM ANCHO / ESPESOR IN MM	LUNGHEZZA IN MM LENGTH IN MM LONGITUD IN MM
18560	KOMORI LITHRONE 20	25 MM X 0,20 MM	550 MM
18562	KOMORI LITHRONE S 26 / SPICA 26	25 MM X 0,20 MM	680 MM
18564	KOMORI LITHRONE 28	25 MM X 0,20 MM	728 MM
18566	KOMORI LITHRONE S 29 / SPICA 29	28 MM X 0,20 MM	791 MM
18568	KOMORI LITHRONE 32	28 MM X 0,20 MM	856 MM
18570	KOMORI LITHRONE 40	28 MM X 0,20 MM	1038 MM
18572	KOMORI LITHRONE S 40	28 MM X 0,20 MM	1085 MM
18574	KOMORI LITHRONE S 44	28 MM X 0,20 MM	1156 MM

PER GRUPPO "TRESU" - FOR "TRESU" CHAMBERS - PARA GRUPO "TRESU"

CODICE CODE CODIGO	MODELLO MACCHINA MACHINE MODEL MODELO DE MAQUINA	ALTEZZA / SPESSORE IN MM WIDTH / THICKNESS IN MM ANCHO / ESPESOR IN MM	LUNGHEZZA IN MM LENGTH IN MM LONGITUD IN MM
18580	KOMORI LITHRONE 20	35 MM X 0,20 MM	550 MM
18582	KOMORI LITHRONE S 26 / SPICA 26	35 MM X 0,20 MM	680 MM
18584	KOMORI LITHRONE 28	35 MM X 0,20 MM	728 MM
18586	KOMORI LITHRONE S 29 / SPICA 29	35 MM X 0,20 MM	791 MM
18588	KOMORI LITHRONE 32	35 MM X 0,20 MM	856 MM
18592	KOMORI LITHRONE 40	35 MM X 0,20 MM	1038 MM
18596	KOMORI LITHRONE S 40	35 MM X 0,20 MM	1085 MM
18600	KOMORI LITHRONE S 44	35 MM X 0,20 MM	1156 MM

# SUPER DOCTOR BLADES

IN PLASTICA - IN PLASTIC - EN PLASTICO

DISPONIBILI SU RICHIESTA - AVAILABLE ON REQUEST - DISPONIBLES POR PEDIDO

NEW

SECTION

SECTION

CODICE CODE CODIGO	ALTEZZA / SPESSORE IN MM WIDTH / THICKNESS IN MM ANCHO / ESPESOR IN MM	LUNGHEZZA IN MT. LENGTH IN MT. LONGITUD IN MT.
18705D**	32MM X 0,19MM	ROLL OF 100 MT.
18705C**	35MM X 0,19MM	ROLL OF 100 MT.
18704A	28MM X 0,35MM	ROLL OF 100 MT.
18705A	32MM X 0,35MM	ROLL OF 100 MT.
18705B	35MM X 0,35MM	ROLL OF 100 MT.
18706A	38MM X 0,35MM	ROLL OF 100 MT.

CODICE CODE CODIGO	ALTEZZA / SPESSORE IN MM WIDTH / THICKNESS IN MM ANCHO / ESPESOR IN MM	LUNGHEZZA IN MT. LENGTH IN MT. LONGITUD IN MT.
18702B	32MM X 0,35MM	ROLL OF 100 MT.
18702C	35MM X 0,35MM	ROLL OF 100 MT.



# NEW

# SPECIAL ANILOX SPONGE®

CODE	DESCRIPTION
18645	SPECIAL ANILOX SPONGE

**SPECIAL SPONGE FOR OPTIMAL CLEANING OF THE ANILOX CYLINDER.**

**SPUGNA SPECIALE PER UNA PULIZIA OTTIMALE DEL CILINDRO ANILOX.**

**ESPONJA ESPECIAL PARA UNA LIMPIEZA ÓPTIMA DEL CILINDRO ANILOX.**

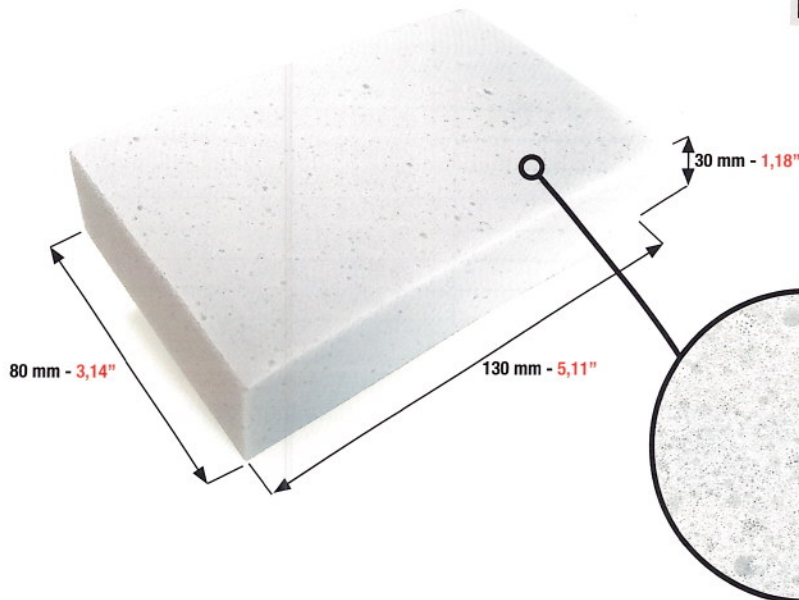

**SUPPLIED IN BOXES OF 50 PCS**

Special top quality material.  
Materiale speciale di altissima qualità.  
Material especial de primera calidad.

**PERFECT FOR EVERY ANILOX DESIGN - PERFETTO SU QUALSIASI TIPO DI ANILOX  
PERFECTO PARA CADA DISEÑO DE ANILOX**

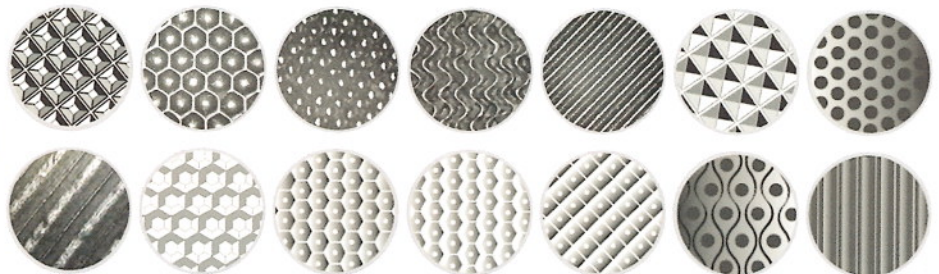
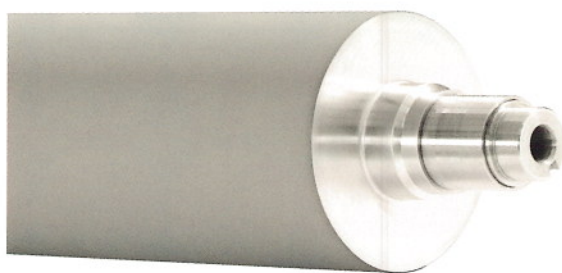

**REQUEST BY E-MAIL THE PRICE LIST RESERVED FOR YOU.  
RICHIEDETE PER E-MAIL IL LISTINO PREZZI A VOI RISERVATO.  
SOLICITE POR CORREO ELECTRONICO LA LISTA DE PRECIOS RESERVADA PARA USTED.**







# ROYAL TOP PLATE®

THE NUMBER ONE SINCE 1987



## HIGH QUALITY COATING PLATES

### SURFACE IN RESIN

- VERY EASY TO STRIP.
- 100% SPLITTING (COATING TRANSFER).
- NO INK BUILD-UP.
- SHARP AND CLEAN EDGES EVEN AFTER LONG PRINT RUNS.
- COMPATIBLE WITH ALL TYPES OF COATINGS: UV, WATER-BASED, GLOSSY, MATT, ETC..
- HIGH DIMENSIONAL STABILITY ALWAYS GUARANTEES A PERFECT REGISTER.
- AVAILABLE IN ANY SIZE.

#### SPECS:

COLOUR	Blue	Blue	Blue
BI-DIRECTIONAL	Yes	Yes	Yes
CARRIER	Polyester	Polyester	Polyester
NOMINAL THICKNESS MM Tolerance +/- 0,02mm	1,15mm	1,35mm	1,95mm
THICKNESS OF CARRIER	0,35mm	0,35mm	0,35mm
THICKNESS OF THERMOPLASTIC STRIPPING LAYER MM	0,80mm	1,00mm	1,60mm
COATING COMPATIBILITY	Water-based and UV	Water based and UV	Water based and UV
ROUGHNESS (Ra:µm)	0,8 – 1,2 µm	0,8 – 1,2 µm	0,8 – 1,2 µm
STRIPPING DEPTH MM	0,80mm	1,00mm	1,60mm
SURFACE HARDNESS (Shore A)	75°	75°	75°





# ROYAL COAT COATING PLATES WITH RUBBER SURFACE

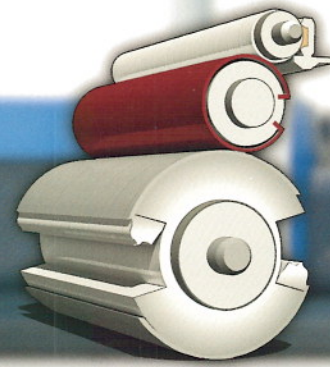

## ROYAL COAT

COLOUR	Blue	Blue	Blue
BI-DIRECTIONAL	Yes	Yes	Yes
CARRIER	Polyester	Polyester	Polyester
NOMINAL THICKNESS MM Tolerance +/- 0,02mm	1,15mm	1,35mm	1,95mm
THICKNESS OF CARRIER	0,35mm	0,35mm	0,35mm
COMPRESSIBLE layer	-	-	yes
THICKNESS OF COMPRESSIBLE LAYER MM	-	-	0,60
COATING COMPATIBILITY	aqueous + UV	aqueous + UV	aqueous + UV
ROUGHNESS (Ra:µm)	0,6 – 0,9 µm	0,6 – 0,9 µm	0,6 – 0,9 µm
STRIPPING DEPTH MM	0,80mm	1,00mm	1,00mm

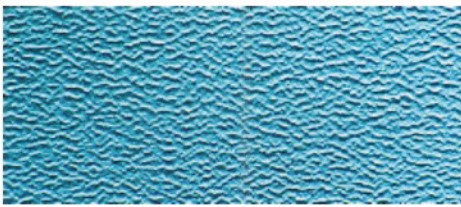

## ROYAL COAT PLUS "DUAL PURPOSE"

COLOUR	Grey	Grey	Grey
BI-DIRECTIONAL	Yes	Yes	Yes
CARRIER	Polyester	Polyester	Polyester
NOMINAL THICKNESS MM Tolerance +/- 0,02mm	1,15mm	1,35mm	1,95mm
THICKNESS OF CARRIER	0,35mm	0,35mm	0,35mm
COMPRESSIBLE layer	-	-	yes
THICKNESS OF COMPRESSIBLE LAYER MM	-	-	0,60
COATING COMPATIBILITY	aqueous + UV	aqueous + UV	aqueous + UV
ROUGHNESS (Ra:µm)	0,5 – 0,7 µm	0,5 – 0,7 µm	0,5 – 0,7 µm
STRIPPING DEPTH MM	0,80mm	1,00mm	1,00mm



## ROYAL COAT UV SPECTRA

COLOUR	Orange	Orange	Orange
BI-DIRECTIONAL	Yes	Yes	Yes
CARRIER	Polyester	Polyester	Polyester
NOMINAL THICKNESS MM Tolerance +/- 0,02mm	1,15mm	1,35mm	1,95mm
THICKNESS OF CARRIER	0,35mm	0,35mm	0,35mm
COMPRESSIBLE layer	-	-	yes
THICKNESS OF COMPRESSIBLE LAYER MM	-	-	0,60
COATING COMPATIBILITY	UV	UV	UV
ROUGHNESS (Ra:µm)	0,6 – 0,8 µm	0,6 – 0,8 µm	0,6 – 0,8 µm
STRIPPING DEPTH MM	0,80mm	1,00mm	1,00mm

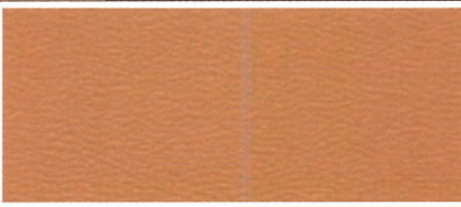

## ROYAL SUPERCOAT

COLOUR	Patina Green	Patina Green	Patina Green
BI-DIRECTIONAL	Yes	Yes	Yes
CARRIER	Polyester	Polyester	Polyester
NOMINAL THICKNESS MM Tolerance +/- 0,02mm	1,15mm	1,35mm	1,95mm
THICKNESS OF CARRIER	0,35mm	0,35mm	0,35mm
COMPRESSIBLE layer	Yes	Yes	Yes
COATING COMPATIBILITY	Aqueous + UV	Aqueous + UV	Aqueous + UV
ROUGHNESS (Ra:µm)	0,6 – 0,9 µm	0,6 – 0,9 µm	0,6 – 0,9 µm
STRIPPING DEPTH MM	0,80mm	1,00mm	1,60mm



## RSB ROYAL STRIP BLANKETS



COLOUR	BLUE
CONSTRUCTION	3 FABRIC LAYERS
COMPRESSIBLE LAYER	CLOSED CELLS
THICKNESS MM	1,95 ± 0,02 MM
HARDNESS ( TOTAL )	80° SHORE A
TENSILE STRENGTH	105 ( N/MM )
COMPRESSIBILITY	650 N/3 CM <sup>2</sup>
APPLICATION FIELDS	VARNISHING GROUP
IDENTIFICATION LINES	SINGLE LINE
INK COMPATIBILITY	70% ACRYLIC VARNISH, 30% UV VARNISH



ROYAL UNDER COAT

# ROYAL UNDER COAT®

UNDERPACKING SPECIFIC  
FOR COATING PLATES

\*MOST FREQUENTLY USED THICKNESS

## ROYAL UNDERCOAT NON ADHESIVE

- FABRIC
- FABRIC

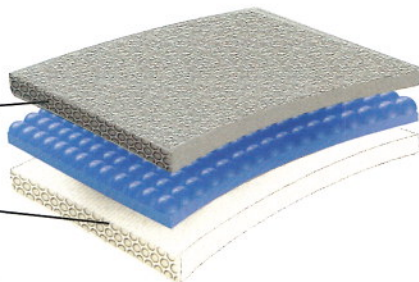

## ROYAL UNDERCOAT ADHESIVE

- FABRIC
- FABRIC
- ADHESIVE



## ROYAL UNDERCOAT ADHESIVE + POLYESTER

- FABRIC
- POLYESTER
- FABRIC
- ADHESIVE

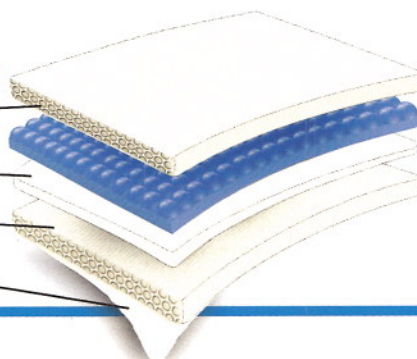

Thicknesses

mm.

0,65  
0,75  
0,85  
0,90  
0,95  
1,00  
1,05  
1,20  
1,30  
1,35  
1,40  
1,45\*  
1,50  
1,65  
1,70  
1,85  
1,95  
2,00  
2,05  
2,10  
2,15  
2,30

other thicknesses  
available on request

Surface: Fabric  
Tolerance +/- 0,01



fogra

cert

FOGRA CERTIFICATION  
IN PREPARATION





**TOP QUALITY**

**VERNICIATURA INDIRETTA - OFF-LINE COATING - BARNIZADO INDIRECTO**

# **SUPER COAT®**

**SPECIALE RIVESTIMENTO PLASTICO AUTOADESIVO PER VERNICIATURA INDIRETTA CON RISERVE  
SPECIAL SELF-ADHESIVE PLASTIC MATERIAL FOR OFF-LINE SPOT COATING**

**REVESTIMIENTO PLASTICO ESPECIAL AUTOADHESIVO PARA BARNIZADO INDIRECTO CON RESERVA**

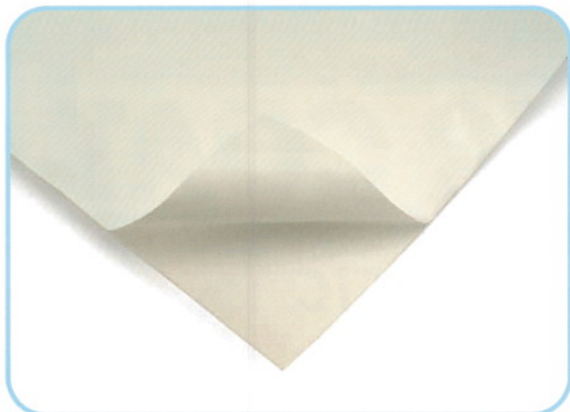

## **SUPER COAT "PLUS"**

SPESSORE THICKNESS ESPESOR		SEMITRASPARENTE SEMITRASPARENT SEMITRASPARENTE		COLORE COLOUR COLOR
mm	inch.		adesivi	
0,53	0,021	x	x	neutro neutral

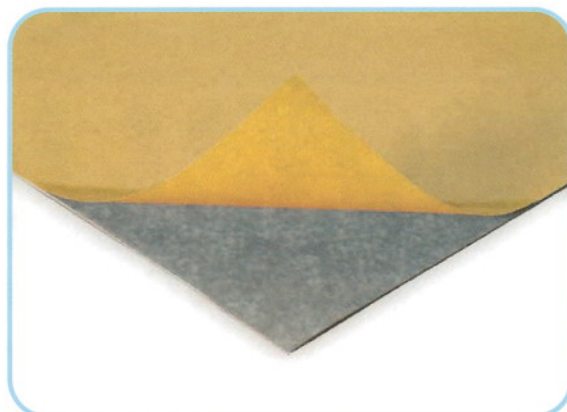

## **SUPER COAT "GREY"**

SPESSORE THICKNESS ESPESOR		SEMITRASPARENTE SEMITRASPARENT SEMITRASPARENTE		COLORE COLOUR COLOR
mm	inch.		adesivi	
0,70	0,028	-	x	grigio grey/gris

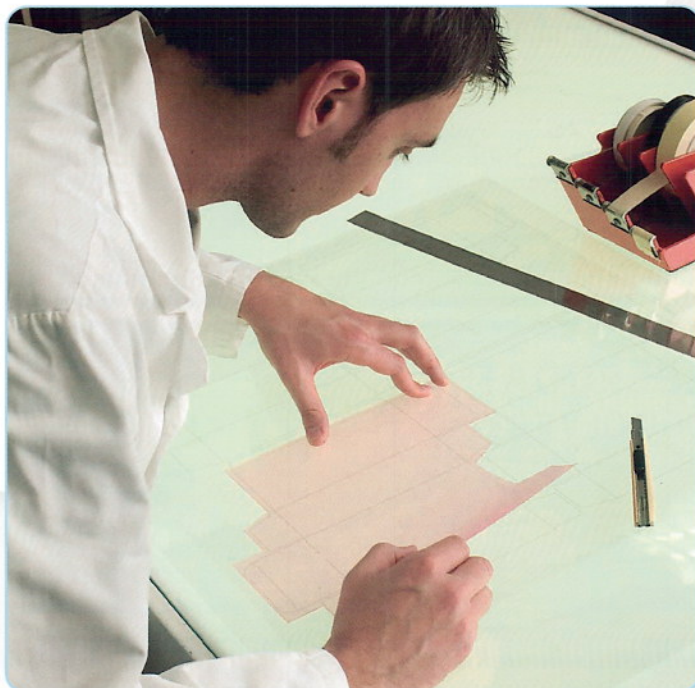

**SUPER COAT PUÒ ESSERE FORNITO IN ROTOLO O IN QUALSIASI FORMATO RICHIESTO  
SUPER COAT CAN BE SUPPLIED IN ROLLS OR IN ANY SIZE OF CUT SHEETS YOU WISH TO REQUEST  
BAJO PEDIDO PODEMOS SUMINISTRAR EL SUPER COAT EN ROLLOS O CORTADO EN CUALQUIER FORMATO**





**CINGHIE DI RALLENTAMENTO FOGLI  
SHEET SLOWDOWN BELTS  
CORREAS PARA REDUCIR LA MARCHA DE LA HOJA**

**26**  
FORI / HOLES  
AGUJEROS

210 mm x 14 mm  
8,27" x 0,55"

CINGHIA DI RALLENTAMENTO FOGLI RIALZATA PER:  
RAISED SHEET SLOWDOWN BELT FOR:  
CORREA REALZADA PARA REDUCIR LA MARCHA DE LA HOJA PARA:

**KOMORI LITHRONE 40/440/540/640/840**  
TUTTI I MODELLI - ALL MODELS - TODOS LOS MODELOS

COMPATIBLE WITH OEM CODE	CODICE - CODE - CÓDIGO
<b>GFH-8310-902</b>	<b>6082</b>

**13**  
FORI / HOLES  
AGUJEROS

210 mm x 14 mm  
8,27" x 0,55"

6082-A

CINGHIA DI RALLENTAMENTO FOGLI RIALZATA PER:  
RAISED SHEET SLOWDOWN BELT FOR:  
CORREA REALZADA PARA REDUCIR LA MARCHA DE LA HOJA PARA:

**KOMORI LITHRONE 40/440/540/640/840**  
TUTTI I MODELLI - ALL MODELS - TODOS LOS MODELOS

COMPATIBLE WITH OEM CODE	CODICE - CODE - CÓDIGO
	<b>6082-A</b>

**15**  
FORI / HOLES  
AGUJEROS

210 mm x 14 mm  
8,27" x 0,55"

6082-B

CINGHIA DI RALLENTAMENTO FOGLI RIALZATA PER:  
RAISED SHEET SLOWDOWN BELT FOR:  
CORREA REALZADA PARA REDUCIR LA MARCHA DE LA HOJA PARA:

**KOMORI LITHRONE 40/440/540/640/840**  
TUTTI I MODELLI - ALL MODELS - TODOS LOS MODELOS

COMPATIBLE WITH OEM CODE	CODICE - CODE - CÓDIGO
	<b>6082-B</b>

**26**  
FORI / HOLES  
AGUJEROS

210 mm x 14 mm  
8,27" x 0,55"

CINGHIA DI RALLENTAMENTO FOGLI RIALZATA PER:  
RAISED SHEET SLOWDOWN BELT FOR:  
CORREA REALZADA PARA REDUCIR LA MARCHA DE LA HOJA PARA:

**KOMORI LITHRONE 40/440/540/640/840**  
TUTTI I MODELLI - ALL MODELS - TODOS LOS MODELOS

COMPATIBLE WITH OEM CODE	CODICE - CODE - CÓDIGO
<b>GFH-8310-956</b>	<b>6083</b>





5 mm - 0,20"

**35**  
FORI / HOLES  
AGUJEROS

210 mm x 14 mm  
8,27" x 0,55"

**CINGHIA DI RALLENTAMENTO FOGLI RIALZATA PER:**  
**RAISED SHEET SLOWDOWN BELT FOR:**  
**CORREA REALZADA PARA REDUCIR LA MARCHA DE LA HOJA PARA:**

**KOMORI LITHRONE 40/440/540/640/840**  
TUTTI I MODELLI - ALL MODELS - TODOS LOS MODELOS

COMPATIBLE WITH OEM CODE	CODICE - CODE - CÓDIGO
<b>ZP0-8300-101</b>	<b>6084</b>



5 mm - 0,20"

**52**  
FORI / HOLES  
AGUJEROS

210 mm x 14 mm  
8,27" x 0,55"

**CINGHIA DI RALLENTAMENTO FOGLI RIALZATA PER:**  
**RAISED SHEET SLOWDOWN BELT FOR:**  
**CORREA REALZADA PARA REDUCIR LA MARCHA DE LA HOJA PARA:**

**KOMORI LITHRONE 40/440/540/640/840**  
TUTTI I MODELLI - ALL MODELS - TODOS LOS MODELOS

COMPATIBLE WITH OEM CODE	CODICE - CODE - CÓDIGO
<b>GFH-8310-950</b>	<b>6084-A</b>



38 mm  
1,50"

184 mm - 7,24"

**ADESIVO**  
ADHESIVE  
ADHESIVO

**KIT PLASTICA PER FRENAFOGLI PER:**  
**CUSHION TAPE FOR EXIT SHEET SLOWDOWN FOR:**  
**KIT PLASTICO PARA FRENAR LA HOJA PARA:**

**KOMORI LITHRONE G 40**  
(SIMILAR GVD8300100)

CONFEZIONI DA 10PZ PACKETS OF 10 PCS CONFECCIONES DE 10 PZ	CODICE - CODE - CÓDIGO
	<b>6084-B</b>



**AC - CB**

6104 460 mm x 12 mm  
19,29" x 0,47"

6104-A 490 mm x 12 mm  
19,29" x 0,47"

**CINGHIA SPECIALE PER DISPOSITIVO ANTISCARTINO:**  
**SPECIAL BELT FOR ANTI SET.OFF SYSTEM:**  
**CORREA ESPECIAL PARA DISPOSITIVO DE POLVOS ANTIMACULADORES:**

**VEKO**

CODICE - CODE - CÓDIGO
<b>6104</b>
<b>6104-A</b>



6081 442 mm x 8 mm  
17,40" x 0,31"

6081-B 370 mm x 8 mm  
14,57" x 0,31"

**CINGHIA USCITA FOGLI PER:**  
**SHEET DELIVERY BELT FOR:**  
**CORREA DE SALIDA DE LAS HOJAS PARA:**

**6081 KOMORI LITHRONE 40/440/540/640/840**  
**6081-B KOMORI LITHRONE - SPICA 29 - ALL MODELS**

CODICE - CODE - CÓDIGO
<b>6081</b>
<b>6081-B</b>



336 mm x 5 mm  
13,23" x 0,20"

**CINGHIA USCITA FOGLI PER:**  
**SHEET DELIVERY BELT FOR:**  
**CORREA DE SALIDA DE LAS HOJAS PARA:**

**KOMORI LITHRONE 28/428/628**  
TUTTI I MODELLI - ALL MODELS - TODOS LOS MODELOS

CODICE CODE - CÓDIGO
<b>6081-A</b>



# SUPERIOR MAGNIFYING GLASSES LENTINI E MICROSCOPI ILLUMINATI - MAGNIFYING GLASSES CUENTAHILOS Y MICROSCOPIOS ILUMINADOS



**NEW**



**NEW**



**MASTER MAG** | CODICE - CODE - CÓDIGO  
(12x + LIGHT) | **13536**

**NEW**

**SPACE MAG** | CODICE - CODE - CÓDIGO  
(10x + LIGHT) | **13531**



**ULTRA MAG** | CODICE - CODE - CÓDIGO  
(60x - 120x + LIGHT) | **13533**

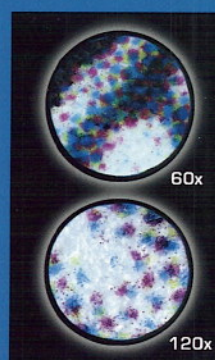

**NEW**





CODICE CODE - CÓDIGO	MISURA SIZE - MEDIDA	INGRANDIMENTI ENLARGEMENTS - AUMENTOS
<b>13501</b>	<b>15x15</b>	<b>10</b>



CODICE CODE - CÓDIGO	MISURA SIZE - MEDIDA	INGRANDIMENTI ENLARGEMENTS - AUMENTOS
<b>13505</b>	<b>20x20</b>	<b>8</b>



CODICE CODE - CÓDIGO	MISURA SIZE - MEDIDA	INGRANDIMENTI ENLARGEMENTS - AUMENTOS
<b>13507</b>	<b>25x25</b>	<b>6</b>



CODICE CODE - CÓDIGO	MICROSCOPIO ILLUMINATO MICROSCOPE WITH LIGHT MICROSCOPIO ILUMINADO	INGRANDIMENTI ENLARGEMENTS - AUMENTOS
<b>13525</b>		<b>50</b>



CODICE CODE - CÓDIGO	MISURA SIZE - MEDIDA	INGRANDIMENTI ENLARGEMENTS - AUMENTOS
<b>13510</b>	<b>30x30</b>	<b>6</b>

**PERSONALIZZABILE - CUSTOMIZABLE - PERSONALIZABLE**



CODICE CODE - CÓDIGO	MISURA SIZE - MEDIDA	INGRANDIMENTI ENLARGEMENTS - AUMENTOS
<b>13510</b>	<b>30x30</b>	<b>6</b>



CODICE CODE - CÓDIGO	MISURA SIZE - MEDIDA	INGRANDIMENTI ENLARGEMENTS - AUMENTOS
<b>13530</b>	<b>-</b>	<b>10</b>

**PERSONALIZZABILE - CUSTOMIZABLE - PERSONALIZABLE**



Questo kit rappresenta la massima espressione della praticità e dell'eleganza. Può essere fornito sia in forma "neutra" o su richiesta con il "logo" stampato ad un colore sul lentino (30x30) e impresso a caldo sulla custodia in cuoio.

This kit represents the maximum in practicality and elegance, it may be supplied in "neutral" form or, on specific request, with the "logo" printed in one colour on the magnifying glass (30x30) and heat-printed on the leather case.

Este kit representa la maxima expresion de lo practico y de la elegancia. Se puede suministrar tanto de forma "neutra", como bajo pedido con el "logo" impreso a un color en el cuentahilos (30x30) e impreso por calor en el estuche de cuero.

CODICE CODE - CÓDIGO	MAGNIFYING GLASSES KIT	CUSTODIA + LENTINO CASE AND MAGNIFYING GLASS ESTUCHE Y CUENTAHILOS
<b>13535</b>		









# STRUMENTI DI CONTROLLO E MISURAZIONE MEASURING AND CONTROLLING INSTRUMENTS INSTRUMENTOS DE CONTROL Y MEDIDA

## TENSION KIT

**KIT TENSIONATORE PER CAUCCIÙ - TENSION KIT FOR BLANKETS - KIT TENSIONADOR DE CAUCHOS**

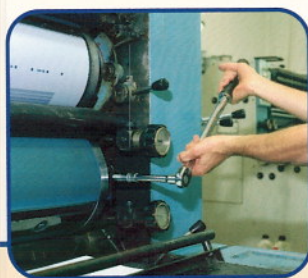

-  IL KIT CHE GARANTISCE "SICUREZZA E QUALITÀ", IL KIT CHE OGNI INDUSTRIA GRAFICA DOVREBBE EQUIPAGGIARE IN DOTAZIONE ALLE PROPRIE MACCHINE DA STAMPA
-  THE KIT THAT GUARANTEES "RELIABILITY AND QUALITY", THE KIT THAT NO PRINT-SHOP SHOULD BE WITHOUT
-  EL KIT QUE GARANTIZA "SEGURIDAD Y CALIDAD", EL KIT CON EL QUE CADA INDUSTRIA GRAFICA DEBERIA ESTAR EQUIPADO, COMO DOTACION A LA PROPIA MAQUINA DE IMPRESION



**CODICE  
CODE  
CÓDIGO  
2722580**

## TOP INDICATOR

**ALCOLOMETRO DI ALTA PRECISIONE - HIGH PRECISION ALCOHOLMETER  
ALCOHOLIMETRO DE ALTA PRECISION**



-  L'ALCOLOMETRO TOP INDICATOR® È LO STRUMENTO PIÙ ECONOMICO, PRECISO E FACILE DA UTILIZZARE INDISPENSABILE PER OGNI INDUSTRIA GRAFICA OGNI QUALVOLTA SI VOGLIA CONTROLLARE LA QUALITÀ DI ALCOOL ISOPROPILICO (IPA) NELLA SOLUZIONE DI BAGNATURA.
-  THE ALCOHOLMETER TOP INDICATOR® IS THE MOST ECONOMICAL, MOST PRECISE AND EASIEST INSTRUMENT TO USE. NO PRINTING COMPANY SHOULD BE WITHOUT ONE WHENEVER THEY NEED TO CHECK THE AMOUNT OF ISOPROPILIC ALCOHOL (IPA) IN THE FOUNTAIN SOLUTION.
-  EL ALCOHOLÍMETRO TOP INDICATOR® ES EL INSTRUMENTO MÁS ECONOMICO, PRECISO Y FACIL DE UTILIZAR, INDISPENSABLE PARA CADA INDUSTRIA GRAFICA PARA CADA VEZ QUE SE QUIERA CONTROLAR LA CALIDAD DEL ALCOHOL ISOPROPÍLICO (IPA) EN LA SOLUCIÓN DE MOJADO.



**CODICE-CODE-CÓDIGO 2722400**

## TOP UNIVERSAL INDIKATOR

**SCALA DI MISURAZIONE "PH" DA 0 A 14 - "PH" MEASURING SCALE FROM 0 TO 14 - ESCALA DE MEDICION "PH" DE 0 A 14**

-  DA SEMPRE LE PIÙ SICURE, PRECISE E AFFIDABILI STRISCE PER LA MISURAZIONE DEL "pH" DELLE SOLUZIONI DI BAGNATURA
-  ALWAYS THE SAFEST, MOST ACCURATE AND RELIABLE STRIPS FOR MEASURING THE "pH" LEVEL IN FOUNTAIN SOLUTIONS
-  DESDE SIEMPRE LA MAS SEGURA, PRECISA Y FIABLE TIRA PARA LA MEDICION DEL "pH" EN LA SOLUCION DE MOJADO

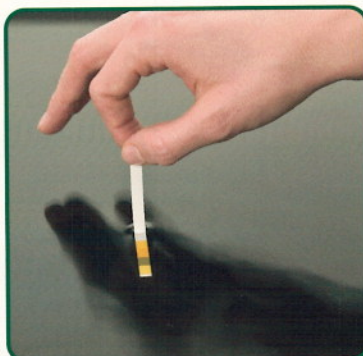

**CODICE-CODE-CÓDIGO 2722217**

**CONFEZIONE IN PLASTICA CONTENENTE 100 STRISCE GRADUATE  
PLASTIC PACKET CONTAINING 100 GRADUATED STRIPS  
CONFECCION EN PLASTICO CONTENIENDO 100 TIRAS GRADUADAS**