

**Special**

DOPPIO STRATO  
DOUBLE LAYER  
DOBLE EXTRACTION

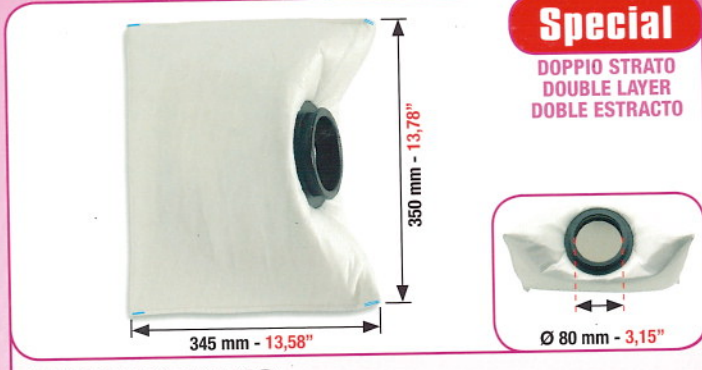

**Special**

DOPPIO STRATO  
DOUBLE LAYER  
DOBLE EXTRACTION

**TECHNOTRANS**

**TECHNOTRANS**

MANROLAND - KBA - MITSUBISHI  
KOMORI - HEIDELBERG

ORDINE MINIMO 2 PEZZI  
MINIMUM ORDER 2 PCS  
PEDIDO MINIMO 2 PIEZAS

CODICE  
CODE - CÓDIGO  
**10000**

CODICE  
CODE - CÓDIGO  
**10001**

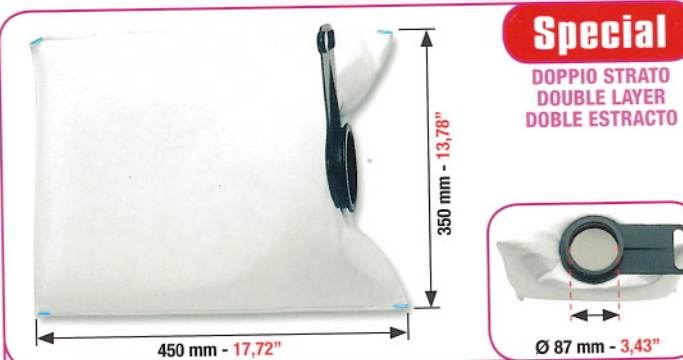

**Special**

DOPPIO STRATO  
DOUBLE LAYER  
DOBLE EXTRACTION

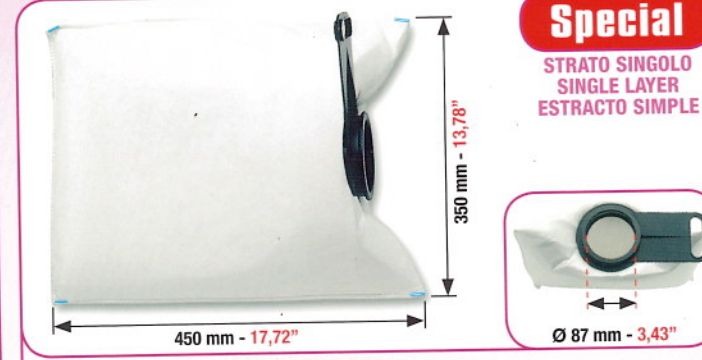

**Special**

STRATO SINGOLO  
SINGLE LAYER  
EXTRACTO SIMPLE

**TECHNOTRANS**

**TECHNOTRANS - LOGOTEC**

MANROLAND - KBA - MITSUBISHI  
KOMORI - HEIDELBERG

MANROLAND - KBA - MITSUBISHI  
KOMORI - HEIDELBERG

ORDINE MINIMO 2 PEZZI  
MINIMUM ORDER 2 PCS  
PEDIDO MINIMO 2 PIEZAS

CODICE  
CODE - CÓDIGO  
**10040**

ORDINE MINIMO 2 PEZZI  
MINIMUM ORDER 2 PCS  
PEDIDO MINIMO 2 PIEZAS

CODICE  
CODE - CÓDIGO  
**10040-B**

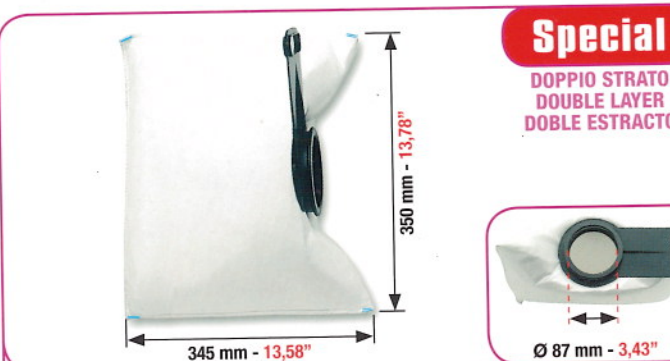

**Special**

DOPPIO STRATO  
DOUBLE LAYER  
DOBLE EXTRACTION

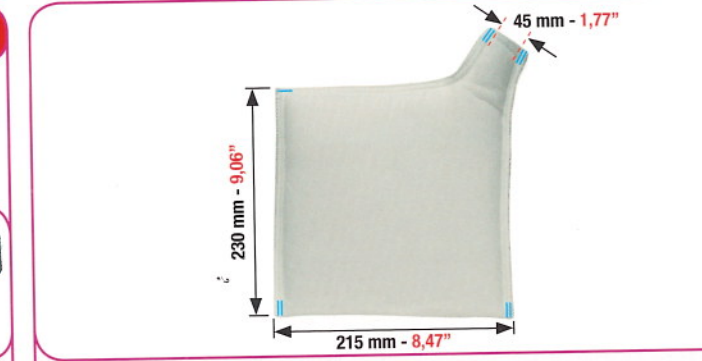

**TECHNOTRANS**

**TECHNOTRANS AQUAPRESS**

RYOBI 520/524 - HEIDELBERG SPEEDMASTER 52/SM74/SM102  
KOMORI LITHRONE 28 - KOMORI 40 etc..

ORDINE MINIMO 2 PEZZI  
MINIMUM ORDER 2 PCS  
PEDIDO MINIMO 2 PIEZAS

CODICE  
CODE - CÓDIGO  
**10039**

ORDINE MINIMO 4 PEZZI  
MINIMUM ORDER 4 PCS  
PEDIDO MINIMO 4 PIEZAS

CODICE  
CODE - CÓDIGO  
**10002**

HEIDELBERG SPEEDMASTER 52 / SM74 / SM102 - KOMORI LITHRONE 28  
KOMORI 40 - RYOBI 520 / 524 - MÜLLER MARTINI etc.

## TECHNOTRANS AQUAPRESS

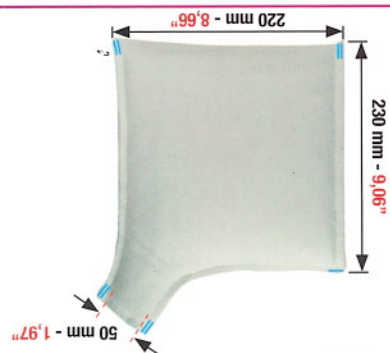

ORDINE MINIMO 4 PEZZI  
MINIMUM ORDER 4 PCS  
PEDIDO MINIMO 4 PIEZAS

**10004**

CODICE  
CODE - CÒDIGO

ORDINE MINIMO 2 PEZZI  
MINIMUM ORDER 2 PCS  
PEDIDO MINIMO 2 PIEZAS

**10006**

CODICE  
CODE - CÒDIGO

## ROYCE

ROYCE MG 7342

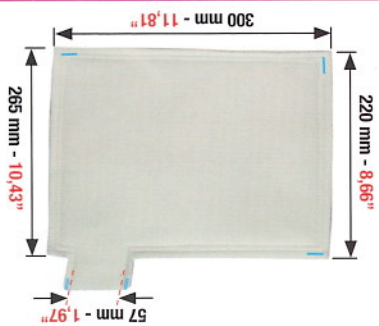

**Special**  
DOPPIO SPESORE  
DOUBLE THICKNESS  
ESPESOR DOBLE

## BALDWIN

KBA - PLANETA



ORDINE MINIMO 4 PEZZI  
MINIMUM ORDER 4 PCS  
PEDIDO MINIMO 4 PIEZAS

**10008-A**

CODICE  
CODE - CÒDIGO

ORDINE MINIMO 4 PEZZI  
MINIMUM ORDER 4 PCS  
PEDIDO MINIMO 4 PIEZAS

**10007**

CODICE  
CODE - CÒDIGO

PER GRUPPI REFRIGERANTI VARI  
FOR DIFFERENT REFRIGERATING SYSTEMS  
PARA GRUPOS DE REFRIGERACION DE VARIOS TIPOS

## BALDWIN

KBA - PLANETA



ORDINE MINIMO 4 PEZZI  
MINIMUM ORDER 4 PCS  
PEDIDO MINIMO 4 PIEZAS

**10008**

CODICE  
CODE - CÒDIGO

ORDINE MINIMO 4 PEZZI  
MINIMUM ORDER 4 PCS  
PEDIDO MINIMO 4 PIEZAS

**10005**

CODICE  
CODE - CÒDIGO

PER GRUPPI REFRIGERANTI VARI  
FOR DIFFERENT REFRIGERATING SYSTEMS  
PARA GRUPOS DE REFRIGERACION DE VARIOS TIPOS

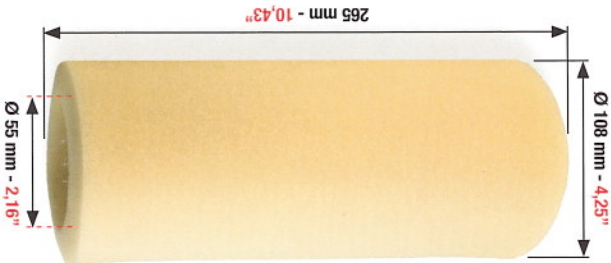



## CREMOPLAST - AQUAPRESS

ORDINE MINIMO 2 PEZZI  
MINIMUM ORDER 2 PCS  
PEDIDO MINIMO 2 PIEZAS

CODICE  
CODE - CÓDIGO  
**10009**

**NEW**

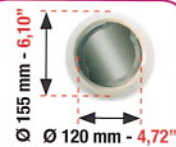

## AKIYAMA

ORDINE MINIMO 2 PEZZI  
MINIMUM ORDER 2 PCS  
PEDIDO MINIMO 2 PIEZAS

CODICE  
CODE - CÓDIGO  
**10015**

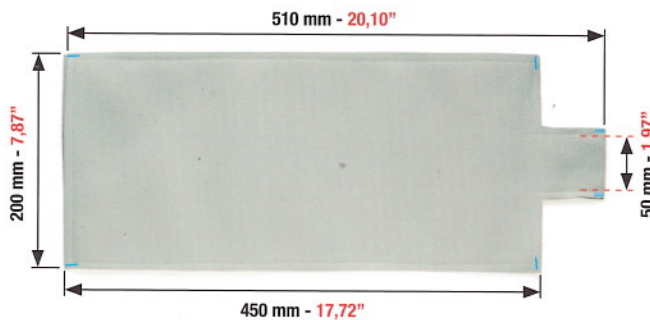

## MG ELECTRIC - CS 1106

ORDINE MINIMO 2 PEZZI  
MINIMUM ORDER 2 PCS  
PEDIDO MINIMO 2 PIEZAS

CODICE  
CODE - CÓDIGO  
**10010**

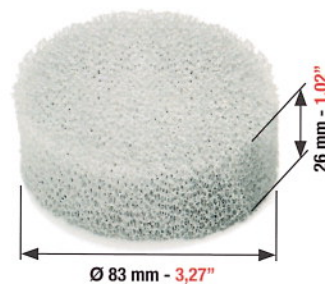

## FILTRO DIFFUSORE DIFFUSER FILTER FILTRO DIFFUSOR

ORDINE MINIMO 4 PEZZI  
MINIMUM ORDER 4 PCS  
PEDIDO MINIMO 4 PIEZAS

CODICE  
CODE - CÓDIGO  
**10011**



## TECHNOTRANS

ORDINE MINIMO 4 PEZZI  
MINIMUM ORDER 4 PCS  
PEDIDO MINIMO 4 PIEZAS

CODICE  
CODE - CÓDIGO  
**10012**

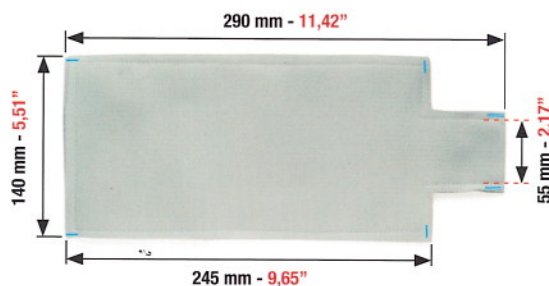

## ROYCE

## ROLAND - KOMORI

ORDINE MINIMO 4 PEZZI  
MINIMUM ORDER 4 PCS  
PEDIDO MINIMO 4 PIEZAS

CODICE  
CODE - CÓDIGO  
**10013**

<b>10026</b> CODICE CODE - CÒDIGO	ORDINE MINIMO 4 PEZZI MINIMUM ORDER 4 PCS PEDIDO MINIMO 4 PIEZAS
	ORDINE MINIMO 4 PEZZI MINIMUM ORDER 4 PCS PEDIDO MINIMO 4 PIEZAS

**WEB OFFSET**

<b>10024</b> CODICE CODE - CÒDIGO	ORDINE MINIMO 4 PEZZI MINIMUM ORDER 4 PCS PEDIDO MINIMO 4 PIEZAS
	ORDINE MINIMO 4 PEZZI MINIMUM ORDER 4 PCS PEDIDO MINIMO 4 PIEZAS

**PER GRUPPI REFRIGERANTI VARI  
FOR DIFFERENT REFRIGERATING SYSTEMS  
PARA GRUPOS DE REFRIGERACION DE VARIOS TIPOS**

<b>10022</b> CODICE CODE - CÒDIGO	ORDINE MINIMO 4 PEZZI MINIMUM ORDER 4 PCS PEDIDO MINIMO 4 PIEZAS
	ORDINE MINIMO 4 PEZZI MINIMUM ORDER 4 PCS PEDIDO MINIMO 4 PIEZAS

**PER GRUPPI REFRIGERANTI VARI  
FOR DIFFERENT REFRIGERATING SYSTEMS  
PARA GRUPOS DE REFRIGERACION DE VARIOS TIPOS**

<b>10020</b> CODICE CODE - CÒDIGO	ORDINE MINIMO 2 PEZZI MINIMUM ORDER 2 PCS PEDIDO MINIMO 2 PIEZAS
	ORDINE MINIMO 2 PEZZI MINIMUM ORDER 2 PCS PEDIDO MINIMO 2 PIEZAS

**TECHNOTRANS  
VECCHI MODELLI - OLD MODELS - MODELOS VIEJOS**

<b>10018</b> CODICE CODE - CÒDIGO	ORDINE MINIMO 2 PEZZI MINIMUM ORDER 2 PCS PEDIDO MINIMO 2 PIEZAS
	ORDINE MINIMO 2 PEZZI MINIMUM ORDER 2 PCS PEDIDO MINIMO 2 PIEZAS

**MG ELECTRIC - HEIDELBERG SPEEDMASTER 52 etc  
NUOVI MODELLI - NEW MODELS - NUEVOS MODELOS**

**TECHNOTRANS**

<b>10016</b> CODICE CODE - CÒDIGO	ORDINE MINIMO 4 PEZZI MINIMUM ORDER 4 PCS PEDIDO MINIMO 4 PIEZAS
	ORDINE MINIMO 4 PEZZI MINIMUM ORDER 4 PCS PEDIDO MINIMO 4 PIEZAS

**ROYCE**



PER GRUPPI REFRIGERANTI VARI  
FOR DIFFERENT REFRIGERATING SYSTEMS  
PARA GRUPOS DE REFRIGERACIÓN DE VARIOS TIPOS

ORDINE MINIMO 4 PEZZI  
MINIMUM ORDER 4 PCS  
PEDIDO MINIMO 4 PIEZAS

CODICE  
CODE - CÓDIGO  
**10028**

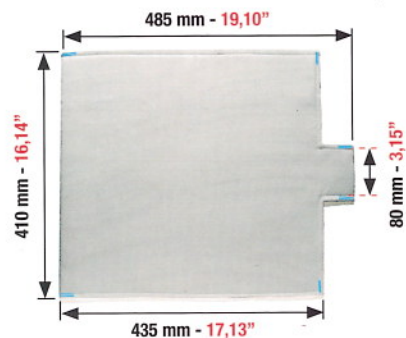

WEB OFFSET

ORDINE MINIMO 2 PEZZI  
MINIMUM ORDER 2 PCS  
PEDIDO MINIMO 2 PIEZAS

CODICE  
CODE - CÓDIGO  
**10014**



**Special**

DOPPIO SPESSORE  
DOUBLE THICKNESS  
ESPEJOR DOBLE

KOMORI LITHRONE 40/440/540/640/840  
MG ELECTRIC - MOD. OPTIMA

ORDINE MINIMO 2 PEZZI  
MINIMUM ORDER 2 PCS  
PEDIDO MINIMO 2 PIEZAS

CODICE  
CODE - CÓDIGO  
**10030**

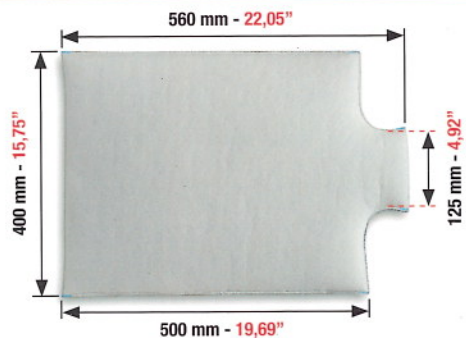

TECHNOTRANS

ORDINE MINIMO 2 PEZZI  
MINIMUM ORDER 2 PCS  
PEDIDO MINIMO 2 PIEZAS

CODICE  
CODE - CÓDIGO  
**10032**

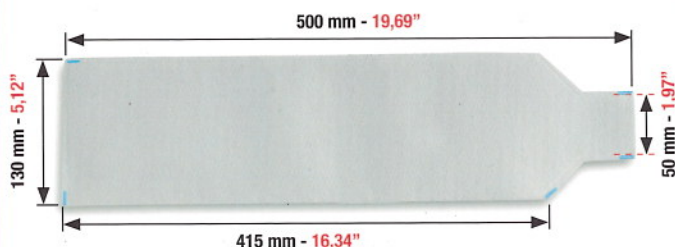

TECHNOTRANS

ORDINE MINIMO 4 PEZZI  
MINIMUM ORDER 4 PCS  
PEDIDO MINIMO 4 PIEZAS

CODICE  
CODE - CÓDIGO  
**10034**

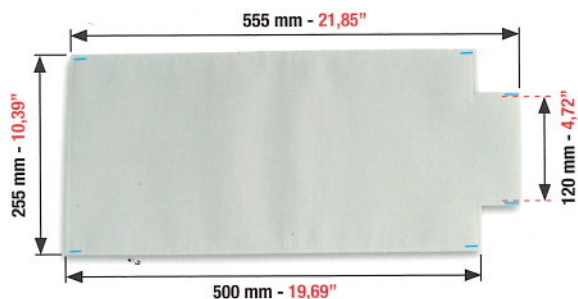

PER: MACCHINE ROTATIVE  
FOR - PARA: WEB OFFSET

ORDINE MINIMO 2 PEZZI  
MINIMUM ORDER 2 PCS  
PEDIDO MINIMO 2 PIEZAS

CODICE  
CODE - CÓDIGO  
**10036**

ORDINE MINIMO 4 PEZZI MINIMUM ORDER 4 PCS PEDIDO MINIMO 4 PIEZAS		<b>10049</b> CODICE CODE - CÒDIGO
ROLAND 200/300		

**TECHNOTRANS**

ORDINE MINIMO 2 PEZZI MINIMUM ORDER 2 PCS PEDIDO MINIMO 2 PIEZAS		<b>10047</b> CODICE CODE - CÒDIGO
TECHNOTRANS		

ORDINE MINIMO 2 PEZZI MINIMUM ORDER 2 PCS PEDIDO MINIMO 2 PIEZAS		<b>10042</b> CODICE CODE - CÒDIGO
KBA 142/162A		

**TECHNOTRANS**

ORDINE MINIMO 4 PEZZI MINIMUM ORDER 4 PCS PEDIDO MINIMO 4 PIEZAS		<b>10041</b> CODICE CODE - CÒDIGO
KBA 104/105 PER GRUPPI REFRIGERANTI VARI FOR DIFFERENT REFRIGERATING SYSTEMS PARA GRUPOS DE REFRIGERACIÓN DE VARIOS TIPOS		

ORDINE MINIMO 2 PEZZI MINIMUM ORDER 2 PCS PEDIDO MINIMO 2 PIEZAS		<b>10044</b> CODICE CODE - CÒDIGO
TECHNOTRANS - PRINTING TECHNOLOGY		

ORDINE MINIMO 2 PEZZI MINIMUM ORDER 2 PCS PEDIDO MINIMO 2 PIEZAS		<b>10038</b> CODICE CODE - CÒDIGO
TECHNOTRANS		

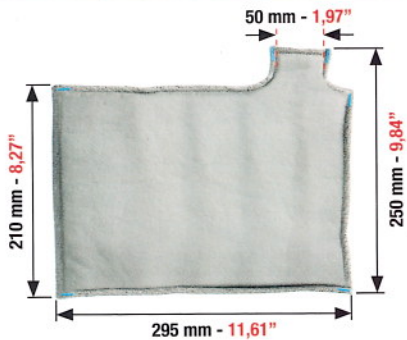

PER GRUPPI REFRIGERANTI VARI  
FOR DIFFERENT REFRIGERATING SYSTEMS  
PARA GRUPOS DE REFRIGERACIÓN DE VARIOS TIPOS

ORDINE MINIMO 4 PEZZI  
MINIMUM ORDER 4 PCS  
PEDIDO MINIMO 4 PIEZAS

CODICE  
CODE - CÓDIGO  
**10051**



PER GRUPPI REFRIGERANTI VARI  
FOR DIFFERENT REFRIGERATING SYSTEMS  
PARA GRUPOS DE REFRIGERACIÓN DE VARIOS TIPOS

ORDINE MINIMO 4 PEZZI  
MINIMUM ORDER 4 PCS  
PEDIDO MINIMO 4 PIEZAS

CODICE  
CODE - CÓDIGO  
**10053**

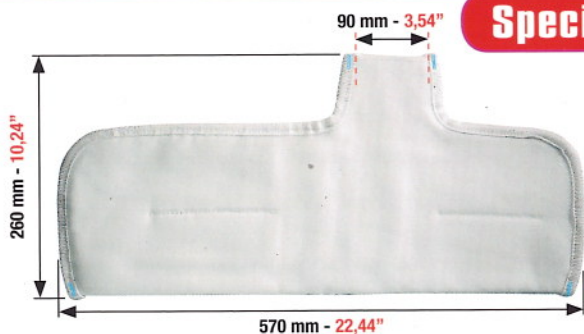

PER GRUPPI REFRIGERANTI VARI  
FOR DIFFERENT REFRIGERATING SYSTEMS  
PARA GRUPOS DE REFRIGERACIÓN DE VARIOS TIPOS

ORDINE MINIMO 2 PEZZI  
MINIMUM ORDER 2 PCS  
PEDIDO MINIMO 2 PIEZAS

CODICE  
CODE - CÓDIGO  
**10055**



PER GRUPPI REFRIGERANTI VARI  
FOR DIFFERENT REFRIGERATING SYSTEMS  
PARA GRUPOS DE REFRIGERACIÓN DE VARIOS TIPOS

ORDINE MINIMO 4 PEZZI  
MINIMUM ORDER 4 PCS  
PEDIDO MINIMO 4 PIEZAS

CODICE  
CODE - CÓDIGO  
**10057**



PER GRUPPI REFRIGERANTI VARI  
FOR DIFFERENT REFRIGERATING SYSTEMS  
PARA GRUPOS DE REFRIGERACIÓN DE VARIOS TIPOS

ORDINE MINIMO 2 PEZZI  
MINIMUM ORDER 2 PCS  
PEDIDO MINIMO 2 PIEZAS

CODICE  
CODE - CÓDIGO  
**10059**



PER GRUPPI REFRIGERANTI VARI  
FOR DIFFERENT REFRIGERATING SYSTEMS  
PARA GRUPOS DE REFRIGERACIÓN DE VARIOS TIPOS

ORDINE MINIMO 2 PEZZI  
MINIMUM ORDER 2 PCS  
PEDIDO MINIMO 2 PIEZAS

CODICE  
CODE - CÓDIGO  
**10061**



<b>10074</b> CODICE CODE - CÒDIGO	ORDINE MINIMO 5 PEZZI MINIMUM ORDER 5 PCS PEDIDO MINIMO 5 PIEZAS

<b>10072</b> CODICE CODE - CÒDIGO	ORDINE MINIMO 5 PEZZI MINIMUM ORDER 5 PCS PEDIDO MINIMO 5 PIEZAS

**BALDWIN**  
**KBA 106**

<b>10070</b> CODICE CODE - CÒDIGO	ORDINE MINIMO 2 PEZZI MINIMUM ORDER 2 PCS PEDIDO MINIMO 2 PIEZAS

**PRINTING TECHNOLOGY**

<b>10065</b> CODICE CODE - CÒDIGO	ORDINE MINIMO 2 PEZZI MINIMUM ORDER 2 PCS PEDIDO MINIMO 2 PIEZAS

**PER GRUPPI REFRIGERANTI VARI  
 FOR DIFFERENT REFRIGERATING SYSTEMS  
 PARA GRUPOS DE REFRIGERACIÓN DE VARIOS TIPOS**

<b>10063</b> CODICE CODE - CÒDIGO	ORDINE MINIMO 4 PEZZI MINIMUM ORDER 4 PCS PEDIDO MINIMO 4 PIEZAS



# MAGIC Air FILTER

FILTRI ARIA CABINE IMPIANTI E ASPIRAZIONI  
 AIR FILTERS FOR ASPIRATION SYSTEMS  
 FILTROS DE AIRE PARA IMPLANTES DE ASPIRACION



**HEIDELBERG**

CODICE CODE - CÓDIGO
<b>10080</b>



**HEIDELBERG**

CODICE CODE - CÓDIGO
<b>10088</b>

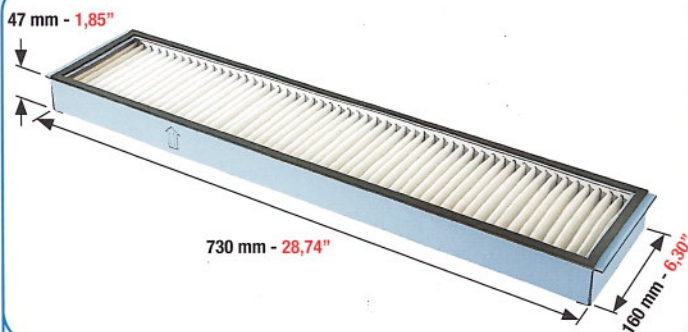

**HEIDELBERG**

CODICE CODE - CÓDIGO
<b>10084</b>



**HEIDELBERG**

CODICE CODE - CÓDIGO
<b>10086</b>

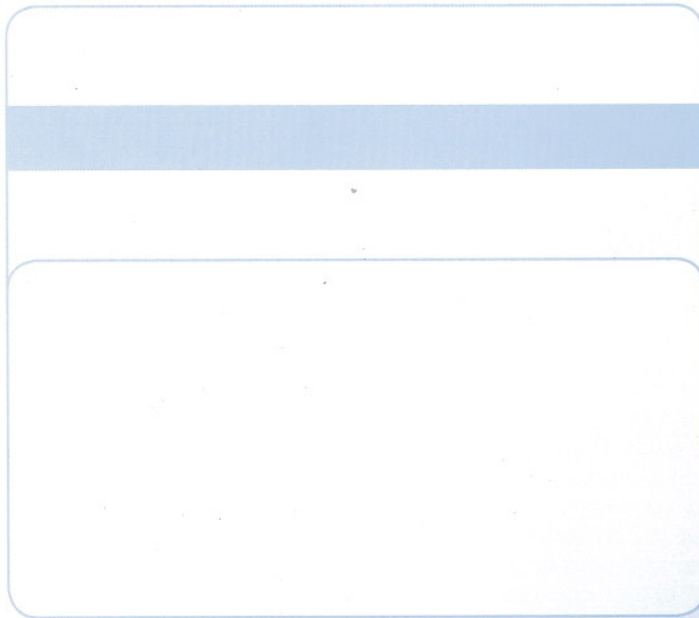
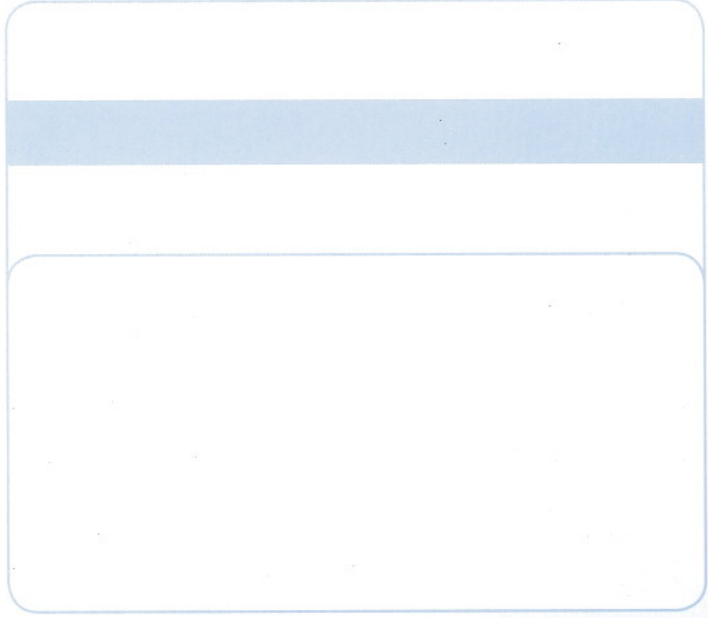
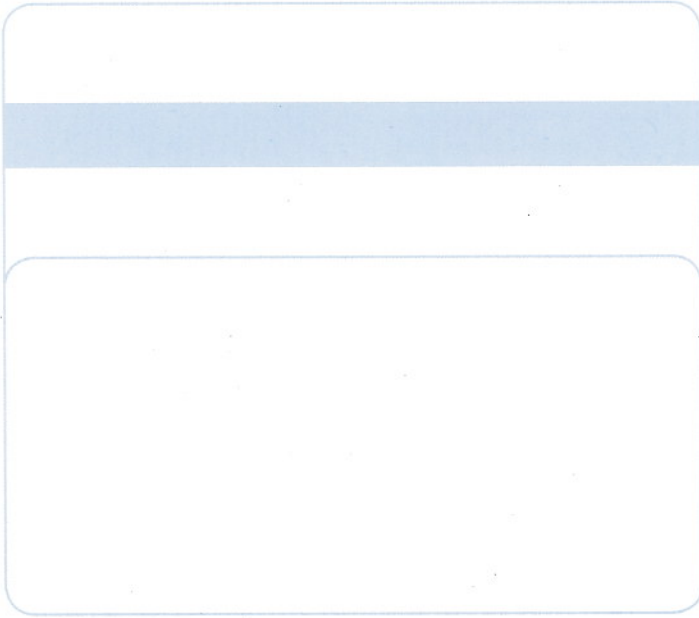

**HEIDELBERG**

**10090**  
CODICE CODE - CODIGO



Ø 128 mm - 5.04"  
78 mm - 3.07"  
Ø 45 mm - 1.77"

**HEIDELBERG**

**10094**  
CODICE CODE - CODIGO



Ø 42,5 mm - 1,67"  
88 mm - 3,46"  
Ø 22 mm - 0,87"

**HEIDELBERG**

**10082**  
CODICE CODE - CODIGO

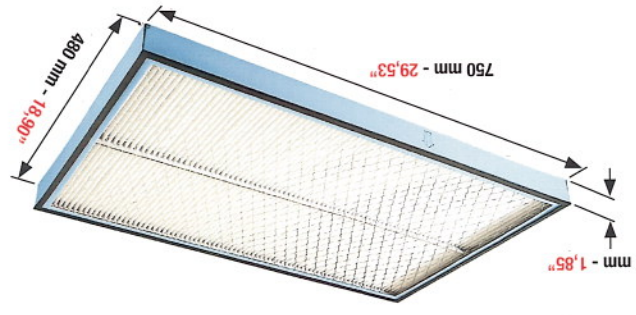

750 mm - 29,53"  
480 mm - 18,90"  
47 mm - 1,85"

# Fat Vampire® FOUNTAIN



**IL VAMPIRO DEI SISTEMI DI BAGNATURA FAT VAMPIRE** succhia con voracità tutti quei residui oleosi di inchiostro presenti nella vasca di ritorno dei circuiti di bagnatura.

#### COME SI USA:

Ponete semplicemente **FAT VAMPIRE** nel serbatoio di ricircolo, galleggerà e nel frattempo assorbirà tutti i residui oleosi di inchiostro presenti nel serbatoio e nel ricircolo di bagnatura evitando che arrivino fino alla bagnatura stessa. Una volta saturo ed imbevuto di tutti i residui **FAT VAMPIRE** comincerà ad affondare e dovrà quindi essere sostituito.

#### VANTAGGI:

Con l'utilizzo di **FAT VAMPIRE** si evita la presenza di residui oleosi e grassi di inchiostro nella vasca dell'acqua di ritorno del circuito di bagnatura.

#### IL TUO AMICO VAMPIRO



**THE VAMPIRE OF FOUNTAIN RECIRCULATING SYSTEMS FAT VAMPIRE** voraciously sucks up all those oily ink residues present in the water reservoirs of fountain recirculating systems.

#### HOW TO USE IT:

Simply place **FAT VAMPIRE** in the water reservoir where it will float and absorb all the oily ink residues present in the reservoir and in the fountain recirculating system, thus avoiding that these residues reach the dampening system itself. Once it is saturated and soaked with all the residues, **FAT VAMPIRE** will start to sink and should then be replaced.

#### ADVANTAGES:

By using **FAT VAMPIRE** you can avoid the presence of oily ink residues in the water reservoirs of fountain recirculating systems.

#### YOUR FRIENDLY VAMPIRE



**EL VAMPIRO DE LOS SISTEMAS DE MOJADO FAT VAMPIRE** aspira vorazmente todos los residuos grasos de tinta que se encuentran en el tanque de vuelta de los circuitos de mojado.

#### MODO DE EMPLEO:

Ponga simplemente **FAT VAMPIRE** en el tanque de recirculación: éste flotará y al mismo tiempo absorberá todos los residuos grasos de tinta que hay en el tanque y en el sistema de recirculación del líquido de mojado, evitándose así que dichos residuos lleguen al propio sistema de mojado. Una vez que esté saturado y totalmente empapado de todos los residuos, **FAT VAMPIRE** empezará a sumergirse y deberá ser sustituido por otro nuevo.

#### VENTAJAS QUE OFRECE:

Con el empleo de **FAT VAMPIRE** se evita que haya residuos aceitosos y grasientos de tinta en el tanque de regreso de los circuitos de mojado.

#### SU AMIGO VAMPIRO



ORDINE MINIMO 4 PEZZI  
MINIMUM ORDER 4 PCS  
PEDIDO MINIMO 4 PIEZAS

CODICE  
CODE - CÓDIGO  
**10045**

PREZZO UNITARIO  
UNIT PRICE - PRECIO UNITARIO

PREZZO UNITARIO UNIT PRICE - PRECIO UNITARIO	CODICE CODE - CÓDIGO <b>10048</b>	ORDINE MINIMO 4 PEZZI MINIMUM ORDER 4 PCS PEDIDO MINIMO 4 PIEZAS
---	---	--



"FAT VAMPIRE SORB" puede absorber hasta 4 litros de aceite.

FAT VAMPIRE SORB es un tejido especial absorbente que le permite absorber cualquier tipo de pérdida o derramamiento.



"FAT VAMPIRE SORB" can absorb up to 4 litres of oil.

FAT VAMPIRE SORB is a special absorbent stocking which is capable of absorbing any type of leakage or spillage.



"FAT VAMPIRE SORB" può assorbire fino a 4 litri di olio.

FAT VAMPIRE SORB è una speciale calza assorbente che permette di assorbire qualsiasi tipo di perdita o rovesciamento.



**PULIZIA E SICUREZZA - CLEANLINESS AND SAFETY - LIMPIEZA Y SEGURIDAD**

**Fat** **Vampire** **SORB** <sup>®</sup>

NEW

# MAGIC FILTER®

FILTRI DI RICIRCOLO - RECIRCULATION FILTERS - FILTROS DE RECIRCULACIÓN

**SPECIALE TESSUTO DI FILTRAGGIO PER VASCHE DI RIFLUSSO DEGLI IMPIANTI DI BAGNATURA**  
**SPECIAL FILTERING NET FOR WATER RESERVOIRS OF FOUNTAIN RECIRCULATING SYSTEMS**  
**TEJIDO FILTRANTE ESPECIAL PARA TANQUES DE REFLUJO DE SISTEMAS DE MOJADO**



## MAGIC FILTER

è uno speciale materassino per filtraggio, addensato termicamente da un lato, appositamente realizzato per le vasche di riflusso degli impianti di bagnatura per la depurazione dell'acqua.

## MAGIC FILTER

è stato sviluppato e messo a punto specificamente per le esigenze di pulizia dell'acqua di bagnatura.

## MAGIC FILTER

è disponibile in 62 misure standard. Può essere fornito in qualsiasi misura speciale.



## MAGIC FILTER

is a special filter mat composed of thermally compressed fleece layers, specially developed for the water reservoirs of fountain recirculating systems.

## MAGIC FILTER

is specially developed and suited to the filtering requirements of the dampening water.

## MAGIC FILTER

is available in 62 standard sizes. It can also be supplied in any special size.



## MAGIC FILTER

es una colchoneta filtradora especial, condensada témicamente de un lado, expresamente realizada para el tanque de reflujo del sistema de mojado, para la depuración del agua.

## MAGIC FILTER

ha sido desarrollado y puesto a punto específicamente para las exigencias de limpieza del agua de mojado.

## MAGIC FILTER

puede suministrarse en 62 tamaños estándar, y también en cualquier tamaño especial.

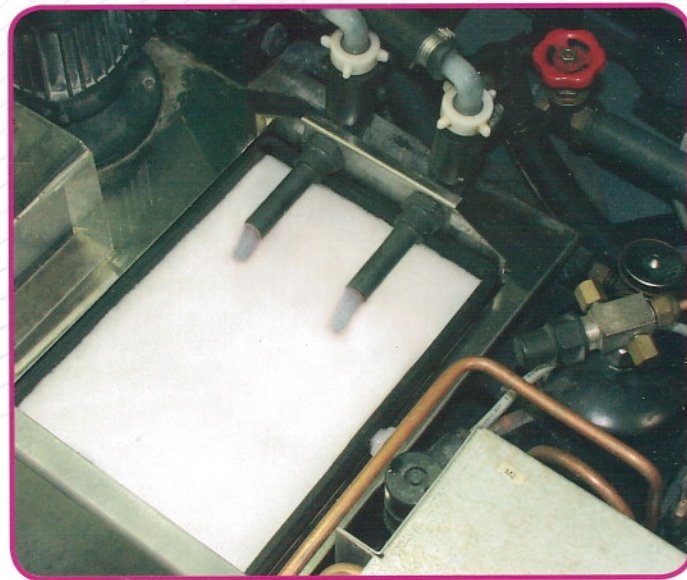

# MAGIC FILTER®

RICHIEDETE IL LISTINO PREZZI RELATIVO ALL'INTERA GAMMA DI MATERASSINI IN FORMATO "MAGIC FILTER®"

ASK FOR THE PRICE LIST REGARDING THE FULL RANGE OF "MAGIC FILTER®" MATS IN CUT PIECES

SOLICITE LA TARIFA DE PRECIOS CORRESPONDIENTE A LA GAMA COMPLETA DE ESTE MATERIAL ACOLCHADO EN FORMATOS "MAGIC FILTER®"

# MAGIC FILTER®

MISURE STANDARD - STANDARD SIZES - TAMAÑOS ESTÁNDAR

MISURE STANDARD - STANDARD SIZES - TAMAÑOS ESTÁNDAR

CODICE • CODE • CÓDIGO

inches	mm	
4.53" X 14.57"	115 X 370	10385
5.51" X 14.96"	140 X 380	10390
5.91" X 13.39"	150 X 340	10400
5.91" X 18.11"	150 X 460	10410
6.30" X 9.84"	160 X 250	10415
6.30" X 10.24"	160 X 260	10416
6.69" X 6.69"	170 X 170	10417
6.69" X 10.24"	170 X 260	10421
7.09" X 7.09"	180 X 180	10418
7.09" X 11.02"	180 X 280	10420
7.09" X 18.90"	180 X 480	10425
7.87" X 11.02"	200 X 280	10430
7.87" X 12.60"	200 X 320	10440
7.87" X 17.32"	200 X 440	10450
8.66" X 10.63"	220 X 270	10453
8.66" X 12.99"	220 X 330	10457
9.06" X 9.06"	230 X 230	10459
9.06" X 18.11"	230 X 460	10465
9.45" X 9.45"	240 X 240	10508
9.45" X 17.72"	240 X 450	10461
9.45" X 18.90"	240 X 480	10468
9.84" X 10.24"	250 X 260	10455
9.84" X 11.42"	250 X 290	10475
9.84" X 11.81"	250 X 300	10460
9.84" X 13.78"	250 X 350	10472
9.84" X 18.50"	250 X 470	10470
9.84" X 26.38"	250 X 670	10480
9.84" X 29.53"	250 X 750	10471
10.24" X 18.70"	260 X 475	10489
10.63" X 12.20"	270 X 310	10483
10.63" X 30.71"	270 X 780	10486
11.81 X 15.75"	300 X 400	10487
11.81 X 18.11"	300 X 460	10481
11.81" X 19.29"	300 X 490	10485
11.81" X 25.20"	300 X 640	10488
12.01" X 45.28"	305 X 1150	10490
12.40" X 25.98"	315 X 660	10500
12.40" X 42.52"	315 X 1080	10501
12.40" X 45.28"	315 X 1150	10502
12.99" X 42.52"	330 X 1080	10504
13.78" X 19.69"	350 X 500	10482
14.17" X 14.17"	360 X 360	10507
14.17" X 22.83"	360 X 580	10509
14.96" X 29.92"	380 X 760	10503
15.35" X 34.65"	390 X 880	10506
15.35" X 76.38"	390 X 1940	10505
15.75" X 15.75"	400 X 400	10510
15.75" X 21.26"	400 X 540	10515
15.75" X 35.43"	400 X 900	10520
16.54" X 18.90"	420 X 480	10525
16.93" X 16.93"	430 X 430	10527
17.32" X 23.62"	440 X 600	10528
17.72" X 61.02"	450 X 1550	10529
19.69" X 19.69"	500 X 500	10532
19.69" X 29.53"	500 X 750	10530
8.07" X 15.9"	205 X 405	10451
8.66" X 25.98"	220 X 660	10458
10.04" X 26.57"	255 X 675	10511
10.63" X 12.60"	270 X 320	10491
11.02" X 14.17"	280 X 360	10484
15.35" X 44.88"	390 X 1140	10531
15.75" X 8.27"	400 X 210	10533

PUÒ ESSERE FORNITO IN QUALSIASI MISURA SPECIALE VENGHA SPECIFICATAMENTE RICHIESTA

CAN ALSO BE SUPPLIED IN ANY SPECIAL SIZE REQUIRED

SE PUEDE SUMINISTRAR EN CUALQUIER TAMAÑO ESPECIAL BAJO PEDIDO