



# ROYAL MEASURING AND CONTROLLING INSTRUMENTS

STRUMENTI DI CONTROLLO E MISURAZIONE  
MEASURING AND CONTROLLING INSTRUMENTS  
INSTRUMENTOS DE CONTROL Y MEDIDA



# TOP UNIVERSAL INDIKATOR

SCALA DI MISURAZIONE "PH" DA 0 A 14 - "PH" MEASURING SCALE FROM 0 TO 14 - ESCALA DE MEDICION "PH" DE 0 A 14

-  DA SEMPRE LE PIÙ SICURE, PRECISE E AFFIDABILI STRISCE PER LA MISURAZIONE DEL "pH" DELLE SOLUZIONI DI BAGNATURA
-  ALWAYS THE SAFEST, MOST ACCURATE AND RELIABLE STRIPS FOR MEASURING THE "pH" LEVEL IN FOUNTAIN SOLUTIONS
-  DESDE SIEMPRE LA MAS SEGURA, PRECISA Y FIABLE TIRA PARA LA MEDICION DEL "pH" EN LA SOLUCION DE MOJADO





CODICE-CODE-CÓDIGO  
**2722217**

CONFEZIONE IN PLASTICA CONTENENTE 100 STRISCE GRADUATE  
PLASTIC PACKET CONTAINING 100 GRADUATED STRIPS  
CONFECCION EN PLASTICO CONTENIENDO 100 TIRAS GRADUADAS

## TOP INDICATOR®

ALCOLOMETRO DI ALTA PRECISIONE - HIGH PRECISION ALCOHOLMETER  
ALCOHOLIMETRO DE ALTA PRECISION



-  L'ALCOLOMETRO TOP INDICATOR® È LO STRUMENTO PIÙ ECONOMICO, PRECISO E FACILE DA UTILIZZARE INDISPENSABILE PER OGNI INDUSTRIA GRAFICA OGNI QUALVOLTA SI VOGLIA CONTROLLARE LA QUALITÀ DI ALCOOL ISOPROPILICO (IPA) NELLA SOLUZIONE DI BAGNATURA.
-  THE ALCOHOLMETER TOP INDICATOR® IS THE MOST ECONOMICAL, MOST PRECISE AND EASIEST INSTRUMENT TO USE. NO PRINTING COMPANY SHOULD BE WITHOUT ONE WHENEVER THEY NEED TO CHECK THE AMOUNT OF ISOPROPILIC ALCOHOL (IPA) IN THE FOUNTAIN SOLUTION.
-  EL ALCOHOLÍMETRO TOP INDICATOR® ES EL INSTRUMENTO MÁS ECONOMICO, PRECISO Y FACIL DE UTILIZAR, INDISPENSABLE PARA CADA INDUSTRIA GRAFICA PARA CADA VEZ QUE SE QUIERA CONTROLAR LA CALIDAD DEL ALCOHOL ISOPROPÍLICO (IPA) EN LA SOLUCIÓN DE MOJADO.





CODICE-CODE-CÓDIGO  
**2722400**





# TOP MICROMETER®

## SPECIALE MICROMETRO CON SUPERFICIE DI CONTATTO A DISCO - SPECIAL MICROMETER WITH DISC CONTACT SURFACE - MICRÓMETRO ESPECIAL CON SUPERFICIE DE CONTACTO DE DISCO

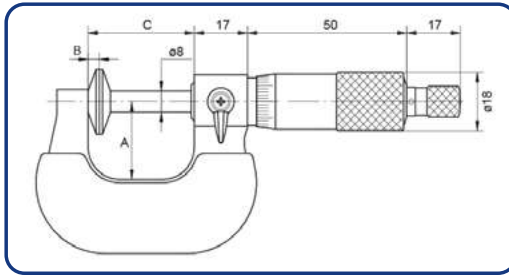

-  STRUMENTO DI ALTISSIMA PRECISIONE IN ACCIAIO FUCINATO VERNICIATO CON GUANCIALINI ISOLANTI. CAMPO DI MISURA 0.01 - 25MM. FORNITO COMPLETO DI ASTUCCIO, ASTA DI RISCONTRO (OLTRE I 25 MM), CHIAVE DI REGOLAZIONE.
-  VERY HIGH PRECISION INSTRUMENT IN PAINTED FORGED STEEL WITH INSULATING CHEEK PADS. MEASUREMENT RANGE 0,01 - 25 MM. SUPPLIED COMPLETE WITH CASE, CHECK ROD (OVER 25 MM), ADJUSTMENT KEY.
-  INSTRUMENTO DE MUY ALTA PRECISIÓN EN ACERO FORJADO PINTADO CON ALMOHADILLAS AISLANTES PARA LAS MEJILLAS. RANGO DE MEDIDA 0,01 - 25 MM. SE SUMINISTRA COMPLETO CON ESTUCHE, VARILLA DE RETENCIÓN (MÁS DE 25 MM), LLAVE DE AJUSTE.



CODICE-CODE-CÓDIGO  
**2722303**

# TOP DIGITAL CONTROLLER®

## SPECIALE MICROMETRO DIGITALE CON SUPERFICIE DI CONTATTO A DISCO SPECIAL DIGITAL MICROMETER WITH DISC CONTACT SURFACE MICRÓMETRO DIGITAL ESPECIAL CON SUPERFICIE DE CONTACTO DE DISCO



-  STRUMENTO DIGITALE DI ALTISSIMA PRECISIONE CON GUANCIALINI ISOLANTI. CAMPO DI MISURA 0.01 - 25MM. FORNITO COMPLETO DI ASTUCCIO E ASTA DI RISCONTRO (OLTRE I 25 MM).
-  VERY HIGH PRECISION DIGITAL INSTRUMENT WITH INSULATING CHEEK PADS. MEASUREMENT RANGE 0,01 - 25 MM. SUPPLIED COMPLETE WITH CASE AND CHECK ROD (OVER 25 MM).
-  INSTRUMENTO DIGITAL DE MUY ALTA PRECISIÓN CON ALMOHADILLAS AISLANTES PARA LAS MEJILLAS. RANGO DE MEDIDA 0,01 - 25 MM. SE SUMINISTRA COMPLETO CON ESTUCHE E VARILLA DE RETENCIÓN (MÁS DE 25 MM).



CODICE-CODE-CÓDIGO  
**2722304**

# TOP DIGITAL MICROMETER®

NUOVO MODELLO - NEW MODEL - NUEVO MODELO - NUOVO MODELLO - NEW MODEL - NUEVO MODELO

-  STRUMENTO DI ALTISSIMA PRECISIONE PER LA MISURAZIONE E LA CALIBRAZIONE DEGLI SPESSORI.
-  TOP QUALITY INSTRUMENT FOR THE MEASUREMENT AND GAUGING OF THE THICKNESSES.
-  INSTRUMENTO DE ALTISIMA PRECISION PARA LA MEDIDA Y LA CALIBRACION DE LOS GROSORES.

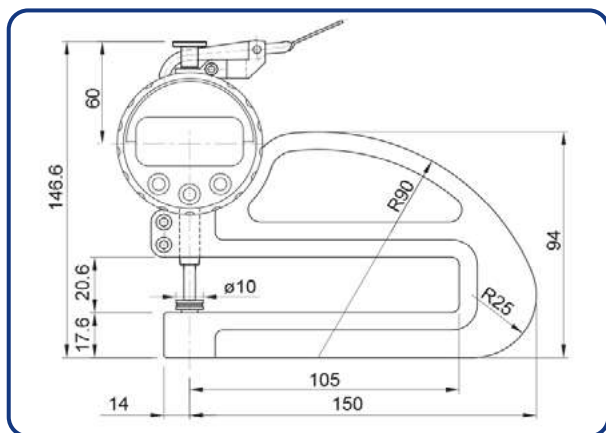



PROGETTATO PER OFFRIRE LA MASSIMA RIGIDITÀ E PRECISIONE.  
DESIGNED TO OFFER MAXIMUM RIGIDITY AND PRECISION.  
DISEÑADO PARA OFRECER LA MÁXIMA RIGIDEZ Y PRECISIÓN.

CODICE-CODE-CÓDIGO  
**2722307**



## TENSION KIT

KIT TENSIONATORE PER CAUCCIÙ  
TENSION KIT FOR BLANKETS  
KIT TENSIONADOR DE CAUCHOS

-  IL KIT CHE GARANTISCE "SICUREZZA E QUALITÀ", IL KIT CHE OGNI INDUSTRIA GRAFICA DOVREBBE EQUIPAGGIARE IN DOTAZIONE ALLE PROPRIE MACCHINE DA STAMPA
-  THE KIT THAT GUARANTEES "RELIABILITY AND QUALITY", THE KIT THAT NO PRINT-SHOP SHOULD BE WITHOUT
-  EL KIT QUE GARANTIZA "SEGURIDAD Y CALIDAD", EL KIT CON EL QUE CADA INDUSTRIA GRAFICA DEBERIA ESTAR EQUIPADO, COMO DOTACION A LA PROPIA MAQUINA DE IMPRESION



CODICE-CODE-CÓDIGO  
**2722580**



ROYAL INSTRUMENTS

## PAPER SCALE

BILANCIA PESA CARTA  
PAPER WEIGHING SCALE  
BÁSCULA DE PESAJE DE PAPEL

-  BILANCIA PESA CARTA DA 0 A 350 GR./M2 - MADE IN GERMANY
-  PAPER WEIGHING SCALE FROM 0 TO 350 GR./M2 - MADE IN GERMANY
-  BÁSCULA DE PESAJE DE PAPEL DE 0 A 350 GR. /M2 - FABRICADA EN ALEMANIA

CODICE-CODE-CÓDIGO  
**2831207**





DON'T FORGET TO

SUBSCRIBE TO OUR

# YouTube CHANNEL



@PavanFornitureGrafiche

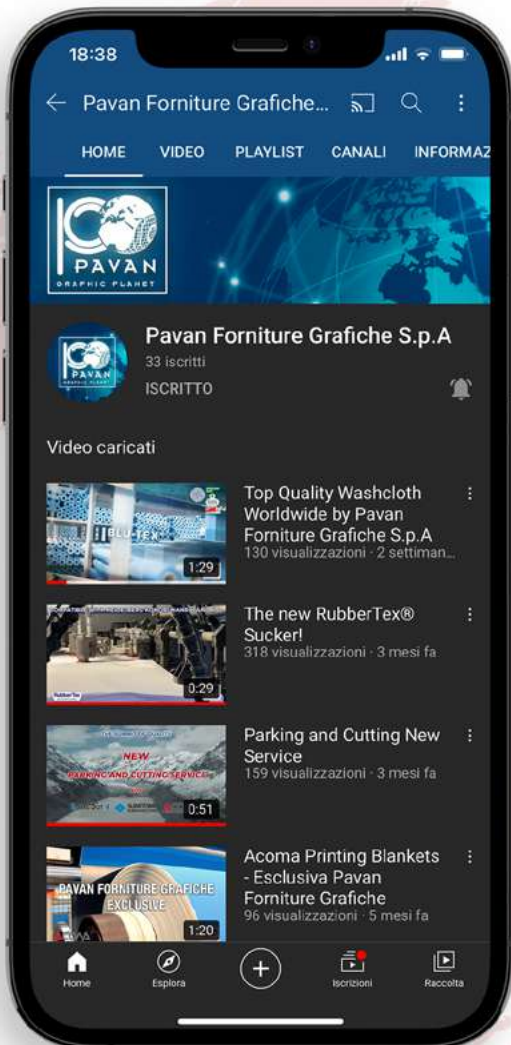

**SCAN THE QR CODE WITH YOUR PHONE  
TO VIEW ALL OUR PRODUCT VIDEOS !!**

**SCANNERIZZA I QR CODE CON IL CELLULARE  
PER VISIONARE TUTTI I VIDEO DEI PRODOTTI !!**

**ESCANEA LOS CÓDIGOS QR CON SU TELÉFONO MÓVIL  
PARA VER TODOS LOS VIDEOS DE LOS PRODUCTOS !!**





PRODUZIONE E DISTRIBUZIONE DI ARTICOLI CONSUMABILI PER L'INDUSTRIA GRAFICA  
PRODUCTION AND DISTRIBUTION OF CONSUMABLES FOR THE PRINTING INDUSTRY  
PRODUCCION Y DISTRIBUCION DE ARTICULOS DE CONSUMO PARA LA INDUSTRIA GRAFICA

إنتاج وتوزيع المواد المستهلكة في صناعة الطباعة

**PAVAN FORNITURE GRAFICHE S.P.A.**

Via dell'Artigianato, 27 - 37062 Dossobuono di Villafranca (VR) - ITALY  
Tel. +39 045 862 0228 / +39 045 862 0688 / +39 045 862 0639 - Fax +39 045  
862 1040

[www.pavanvr.com](http://www.pavanvr.com) - [pavan@pavanvr.com](mailto:pavan@pavanvr.com)

[www.pavanvr.com](http://www.pavanvr.com)  
e-mail: [pavan@pavanvr.com](mailto:pavan@pavanvr.com)

DISTRIBUTORE AUTORIZZATO - AUTHORIZED DISTRIBUTOR - DISTRIBUDOR AUTORIZADO